

SIEMENS



Configuration manual

SENTRON

Miniature circuit breakers

Edition

09/2023

[siemens.com/lowvoltage](https://www.siemens.com/lowvoltage)

SENTRON Miniature Circuit Breakers



Configuration Manual

Introduction	1
5SL miniature circuit breakers (without compact)	2
5SY and 5SP miniature circuit breakers	3
5SL compact miniature circuit breakers, 1+N in 1 MW	4
5SL6 COM miniature circuit breakers with communication and measuring function	5
5SJ6...-.KS miniature circuit breakers, with plug-in terminals	6
Additional components	7
Busbars	8
Configuration and dimensioning	9
5SJ4...-.HG miniature circuit breakers acc. to UL 489 and IEC, and accessories	10
SHU 5SP3 main miniature circuit breakers	11
5SY1 and 5SK9 circuit breakers for equipment	12

Legal information

Warning notice system

This manual contains notices you have to observe in order to ensure your personal safety, as well as to prevent damage to property. The notices referring to your personal safety are highlighted in the manual by a safety alert symbol, notices referring only to property damage have no safety alert symbol. These notices shown below are graded according to the degree of danger.

 DANGER
indicates that death or severe personal injury will result if proper precautions are not taken.
 WARNING
indicates that death or severe personal injury may result if proper precautions are not taken.
 CAUTION
indicates that minor personal injury can result if proper precautions are not taken.
NOTICE
indicates that property damage can result if proper precautions are not taken.

If more than one degree of danger is present, the warning notice representing the highest degree of danger will be used. A notice warning of injury to persons with a safety alert symbol may also include a warning relating to property damage.

Qualified Personnel

The product/system described in this documentation may be operated only by **personnel qualified** for the specific task in accordance with the relevant documentation, in particular its warning notices and safety instructions. Qualified personnel are those who, based on their training and experience, are capable of identifying risks and avoiding potential hazards when working with these products/systems.

Proper use of Siemens products

Note the following:

 WARNING
Siemens products may only be used for the applications described in the catalog and in the relevant technical documentation. If products and components from other manufacturers are used, these must be recommended or approved by Siemens. Proper transport, storage, installation, assembly, commissioning, operation and maintenance are required to ensure that the products operate safely and without any problems. The permissible ambient conditions must be complied with. The information in the relevant documentation must be observed.

Trademarks

All names identified by ® are registered trademarks of Siemens AG. The remaining trademarks in this publication may be trademarks whose use by third parties for their own purposes could violate the rights of the owner.

Disclaimer of Liability

We have reviewed the contents of this publication to ensure consistency with the hardware and software described. Since variance cannot be precluded entirely, we cannot guarantee full consistency. However, the information in this publication is reviewed regularly and any necessary corrections are included in subsequent editions.

Table of contents

1	Introduction	7
2	5SL miniature circuit breakers (without compact)	13
2.1	Overview	13
2.2	Technical specifications	14
2.3	Conductor cross-sections	15
2.4	Dimensional drawings	16
2.5	Graphical symbols.....	17
3	5SY and 5SP miniature circuit breakers	19
3.1	Overview	19
3.2	Technical specifications	20
3.3	Conductor cross-sections	23
3.4	Dimensional drawings	24
3.5	Graphical symbols.....	25
4	5SL compact miniature circuit breakers, 1+N in 1 MW.....	27
4.1	Overview	27
4.2	Technical specifications	28
4.3	Conductor cross-sections	29
4.4	Dimensional drawings	30
4.5	Graphical symbols.....	31
5	5SL6 COM miniature circuit breakers with communication and measuring function	33
5.1	Overview	33
5.2	Technical specifications	34
5.3	Conductor cross-sections	36
5.4	Dimensional drawings	37
5.5	Graphical symbols.....	38
6	5SJ6...-KS miniature circuit breakers, with plug-in terminals	39
6.1	Overview	39
6.2	Technical specifications	40
6.3	Conductor cross-sections	41
6.4	Dimensional drawings	42
6.5	Graphical symbols.....	43

7	Additional components	45
7.1	Overview	45
7.2	Technical specifications	49
7.2.1	Technical specifications for auxiliary switches (AS)	49
7.2.2	Technical specifications for fault signal contacts (FC).....	51
7.2.3	Technical specifications for auxiliary switches (AS) + fault signal contacts (FC).....	53
7.2.4	Technical specifications for 5ST3 COM auxiliary switches / fault signal contacts with communication and measuring function	55
7.2.5	Technical specifications for shunt trips (ST)	56
7.2.6	Technical specifications for undervoltage releases (UR)	57
7.2.7	Technical specifications for remote controlled mechanisms (RC mech.)	58
7.3	Dimensional drawings	59
7.3.1	Dimensional drawings for auxiliary switches (AS)	59
7.3.2	Dimensional drawings for fault signal contacts (FC).....	59
7.3.3	Dimensional drawings for auxiliary switches (AS) + fault signal contacts (FC).....	60
7.3.4	Dimensional drawings for 5ST3 COM auxiliary switches / fault signal contacts with communication and measuring function	60
7.3.5	Dimensional drawings for shunt trips (ST)	60
7.3.6	Dimensional drawings for undervoltage releases (UR)	61
7.3.7	Dimensional drawings for remote controlled mechanisms (RC mech.)	61
7.3.8	Dimensional drawings	62
7.4	Graphical symbols.....	63
7.5	More information	65
8	Busbars	67
8.1	5ST standard busbars.....	67
8.1.1	Overview.....	67
8.1.2	Technical specifications	68
8.2	Compact busbars	69
8.3	Busbars according to UL508, 5ST3	70
8.3.1	Overview.....	70
8.3.2	Technical specifications	71
8.3.3	Dimensional drawing	72
8.4	Busbars - 5ST2 distribution blocks	73
8.4.1	Overview.....	73
8.4.2	Technical specifications	74
8.4.3	Dimensional drawings	78
8.5	SIKclip wiring system	79
8.5.1	Overview.....	79
8.5.2	Technical specifications	79
8.5.3	Dimensional drawings	80

9	Configuration and dimensioning.....	81
9.1	Switching capacity.....	81
9.2	Characteristic curves.....	84
9.2.1	Tripping characteristics acc. to IEC / EN 60898-1, DIN VDE 0641-11.....	84
9.2.2	Tripping characteristics at different ambient temperatures.....	86
9.2.2.1	Tripping behavior at 30 °C ambient temperature.....	86
9.2.2.2	Correction factors for the rated current at different ambient temperatures for 5SL3...- and 5SL6...- (without 5SL30 and 5SL60).....	87
9.2.2.3	Correction factors for the rated current at different ambient temperatures for 5SL30 and 5SL60...-.....	88
9.2.2.4	Correction factors for the rated current at different ambient temperatures for 5SL4...-.....	89
9.2.2.5	Correction factors for the rated current at different ambient temperatures for 5SY.....	90
9.2.2.6	Correction factors for the rated current at different ambient temperatures for 5SP4.....	93
9.2.2.7	Correction factors for the rated current at different ambient temperatures for 5SP5.....	94
9.2.2.8	Correction factors for the rated current at different ambient temperatures for 5SL6 COM.....	95
9.2.3	Correction factors for rated current if bundling.....	96
9.2.4	Correction factors for rated current at different frequencies.....	97
9.2.5	Consideration of minimum clearances.....	99
9.2.6	Internal resistance and power loss.....	115
9.2.6.1	Miniature circuit breakers 5SL3, 5SL6, without 5SL30...- and 5SL60...-.....	115
9.2.6.2	5SL60 COM miniature circuit breaker.....	116
9.2.6.3	5SL4 miniature circuit breakers.....	116
9.2.6.4	5SY4, 5SY6, 5SY7, 5SY8, 5SY5, 5SP4 and 5SP5 miniature circuit breakers.....	117
9.2.6.5	5SP4 and 5SP5 miniature circuit breakers.....	118
9.2.6.6	5SL30, 5SL60 miniature circuit breakers, compact range 1+N in 1 MW.....	118
9.2.7	Characteristic curves for personnel safety with miniature circuit breakers.....	119
9.2.8	Personnel safety with miniature circuit breakers.....	120
9.2.9	Fuse protection of luminaire circuits.....	121
9.2.10	DC applications.....	124
9.3	Selectivity.....	128
9.3.1	Selectivity of miniature circuit breakers/fuses.....	128
9.3.2	Selectivity of miniature circuit breakers/miniature circuit breakers.....	128
9.3.3	Selectivity of miniature circuit breakers/circuit breakers.....	141
9.3.4	Selectivity of miniature circuit breakers/molded case circuit breakers.....	141
9.4	Back-up protection.....	142
9.4.1	Back-up protection of miniature circuit breakers/fuses.....	142
9.4.2	Back-up protection of miniature circuit breakers/molded case circuit breakers.....	145
10	5SJ4...-HG miniature circuit breakers acc. to UL 489 and IEC, and accessories.....	147
10.1	Overview.....	147
10.2	Technical specifications.....	148
10.3	Conductor cross-sections.....	150
10.4	Correction factors for rated current if bundling.....	160
10.5	Dimensional drawings.....	161
10.6	Circuit diagrams.....	163
10.7	More information.....	164

11	SHU 5SP3 main miniature circuit breakers	167
11.1	Overview	167
11.2	Benefits	168
11.3	Technical specifications	169
11.4	Configuration	172
11.5	Characteristic curves	180
11.6	Dimensional drawings	183
11.7	Circuit diagrams.....	185
12	5SY1 and 5SK9 circuit breakers for equipment	187
12.1	Overview	187
12.2	Technical specifications	188
12.3	Conductor cross-sections	190
12.4	Configuration	191
12.5	Characteristic curves	192
12.6	Dimensional drawings	194
12.7	Circuit diagrams.....	195

Introduction

5SL miniature circuit breakers



Application

For all applications from 0.3 A to 63 A in the tripping characteristics B, C and D with rated switching capacities of 4500 A, 6000 A and 10000 A acc. to EN 60898-1.

Standards	Used in		
	Non-residential buildings	Residential buildings	Industry
EN 60898-1	✓	✓	—

See (Page 13)

5SY and 5SP miniature circuit breakers



Application

For all applications from 0.3 A to 125 A with rated switching capacities of 10000 A and 15000 A acc. to EN 60898-1. Applications for universal current from 0.3 A to 63 A, 25 kA version, acc. to EN 60947-2.

Standards	Used in		
	Non-residential buildings	Residential buildings	Industry
EN 60898-1/-2 EN 60947-2 UL 1077 CSA 22.2 GB 10963.1/2	—	✓	✓

See (Page 19)

5SL compact miniature circuit breakers, 1+N in 1 MW



Application

For socket outlet and lighting circuits in all building installations where a switchable neutral conductor is required. The 1+N miniature circuit breaker saves space in the distribution board. This miniature circuit breaker can be used as a built-on device for 5SM60 arc fault detection devices (AFDDs).

Standards	Used in		
	Non-residential buildings	Residential buildings	Industry
EN 60898-1	✓	✓	✓

See (Page 27)

5SL6 COM miniature circuit breakers with communication and measuring function



Application

Compact miniature circuit breaker with communication and measuring function in 1 MW (1+N) record measured values in the branch circuit. Here, electrical variables (current, voltage, power frequency, power, energy) and data on the plant status, such as temperature, operating hours, number of tripping operations and operating cycles are determined. The measured values are transmitted via radio to a 7KN Powercenter 1000 data transceiver, which collects, stores and forwards the data of up to 24 communication-capable circuit protection devices. The SENTRON powerconfig software/app allows measured values to be visualized and parameters such as limit values for warning messages to be set. An early response to alarms enables availability to be increased and maintenance to be planned proactively.

Standards	Used in		
	Non-residential buildings	Residential buildings	Industry
EN 60898-1	✓	✓	✓

See (Page 33)

5SJ6...-KS miniature circuit breakers, with plug-in terminals



Application

For socket outlet and lighting circuits in building installations.

The plug-in terminals offer easy front connection for manual insertion of conductors, which considerably reduces mounting times.

Standards	Used in		
	Non-residential buildings	Residential buildings	Industry
EN 60898-1	✓	✓	—

See (Page 39)

Additional components



Application

Auxiliary switches, fault signal contacts, shunt trips, undervoltage releases for higher system availability, RC units for personal safety and remote controlled mechanisms for remote switching.

Railway applications or applications for extended temperature range (e.g. charging stations) can also be operated with this remote operating mechanism.

Standards	Used in		
	Non-residential buildings	Residential buildings	Industry
—	✓	—	✓

See (Page 45)

Busbars

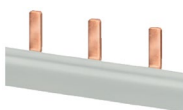

Application

Busbars in 10 mm² and 16 mm² save space in the distribution board and time during mounting. Busbars in 18 mm² and 25 mm² acc. to UL 508 and CSA.

Standards	Used in		
	Non-residential buildings	Residential buildings	Industry
UL 508	✓	✓	✓

See (Page 67)

Configuration and dimensioning

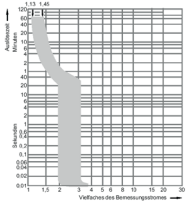

Application

Notes for configuration, dimensioning and extended technical specifications.

See (Page 81)

5SJ4...-HG miniature circuit breakers acc. to UL 489 and IEC, and accessories



Application

Miniature circuit breakers can be used as "branch circuit protection" and are approved for the connection type "same polarity" and "opposite polarity" in the characteristics B, C and D acc. to UL489, from 0.3 to 63 A.

Standards	Used in		
	Non-residential buildings	Residential buildings	Industry
UL 489	✓	✓	✓

See (Page 147)

SHU 5SP3 main miniature circuit breakers



Application

Voltage-independent selective main miniature circuit breakers (SHU) in the precounter area support downstream miniature circuit breakers by providing better current limitation.

Standards	Used in		
	Non-residential buildings	Residential buildings	Industry
DIN VDE 0641-21	✓	✓	—

See (Page 167)

5SY17 and 5SK9 circuit breakers for equipment for advanced applications



Application

Circuit breakers for equipment from Siemens offer optimum protection for all applications in AC and DC control circuits in industrial applications and plant engineering. 5SY17 thermomagnetic circuit breakers for equipment are used to protect solenoid valves, servo motors, signal lamps or even PLC inputs. Everywhere where loads have to be precisely protected from overloads and short-circuits.

5SK9 electronic circuit breakers for equipment are optimally suited to protecting, for example, relays, programmable controllers, motors, sensors, actuators and valves. A current analysis in conjunction with fast tripping in the event of a fault avoid the danger of overloading the switched-mode power supply.

Standards	Used in		
	Non-residential buildings	Residential buildings	Industry
IEC / EN 60934	✓	—	✓

See (Page 187)

5SL miniature circuit breakers (without compact)

2.1 Overview

The 5SL miniature circuit breakers are intended for use up to 6 kA/10 kA. These devices have system features that are characteristic of all Siemens miniature circuit breakers.

They are suitable for the quick and easy mounting of additional components, such as auxiliary switches and fault signal contacts. The 5SL4 miniature circuit breakers can also be combined with shunt trips, undervoltage releases and arc fault detection devices.

To facilitate cable entry, the devices are equipped with rectangular terminals for the accommodation of pin busbars with cables up to 35 mm². The rated current range is between 0.3 A and 63 A. The 5SL miniature circuit breakers are available in characteristics B, C and D.

2.2 Technical specifications

	Unit	5SL3 (without 5SL30)	5SL6 (without 5SL60)	5SL4
Standards		EN 60898-1		
Approvals		see internet (www.siemens.com/lowvoltage/certificates)		
Tripping characteristic		B, C		B, C, D
Rated voltage U_n	V AC	230 / 400		
Operational voltage				
• Min.	V AC/DC per pole	24		
• Max.	V AC	250 / 440		
	V DC per pole	72		
Rated switching capacity				
• I _{cn} acc. to IEC/EN 60898-1	kA AC	4.5	6	10
• I _{cu} acc. to IEC/EN 60947-2	kA AC	4.5	6	10
Insulation coordination				
• Rated insulation voltage	V AC	250 / 440		
• Pollution degree for overvoltage category		2 / III		
Rated frequency	Hz	50 / 60		
Touch protection Acc. to EN 50274		Yes		
Handle end position, sealable		Yes		
Degree of protection		IP20, with connected conductors IP40 in the area of the handle with distribution cover		
CFC and silicone-free		Yes		
Terminals ± screw (Pozidriv)		2		
Recommended terminal tightening torque	Nm	2.5 ... 3		
Mounting position		Any		
Vertical device clearance with DIN rails mounted one above the other (grid distance acc. to IEC/EN 60898-1) ¹⁾	mm	35		
Service life/endurance on average, with rated load		20000 actuations		
Storage temperature	°C	-40 ... +75		
Ambient temperature	°C	-25 ... +45, occasionally +55, max. 95% humidity		-25 ... +55, max. 95% humidity
Resistance to climate Acc. to IEC 60068-2-30		6 cycles		

¹⁾ For more explanations and application notes, see Consideration of minimum clearances (Page 99)

2.3 Conductor cross-sections

Conductor cross-sections		
<i>1 conductor</i>		
• Solid ($\leq 10 \text{ mm}^2$) / stranded ($\geq 16 \text{ mm}^2$)	mm ²	0.75 ... 35
• Finely stranded with non-insulated end sleeve	mm ²	0.75 ... 25
• Finely stranded with insulated end sleeve	mm ²	0.75 ... 25
• Finely stranded without end sleeve	mm ²	1 ... 35
<i>2-wire, same cross-section, same conductor type</i>		
• Solid ($\leq 10 \text{ mm}^2$) / stranded ($\geq 16 \text{ mm}^2$)	mm ²	0.75 ... 10
• Finely stranded with non-insulated end sleeve	mm ²	0.75 ... 4
• Finely stranded with insulated end sleeve	mm ²	0.75 ... 4
• Finely stranded without end sleeve	mm ²	1 ... 4
<i>1-wire + busbar (pin thickness $\leq 1.5 \text{ mm}$)</i>		
• Solid ($\leq 10 \text{ mm}^2$) / stranded ($\geq 16 \text{ mm}^2$)	mm ²	10 ... 25
• Finely stranded with non-insulated end sleeve	mm ²	6 ... 25
• Finely stranded with insulated end sleeve	mm ²	6 ... 16

2.4 Dimensional drawings

5SL3, 5SL4, 5SL6 (without 5SL30 and 5SL60)

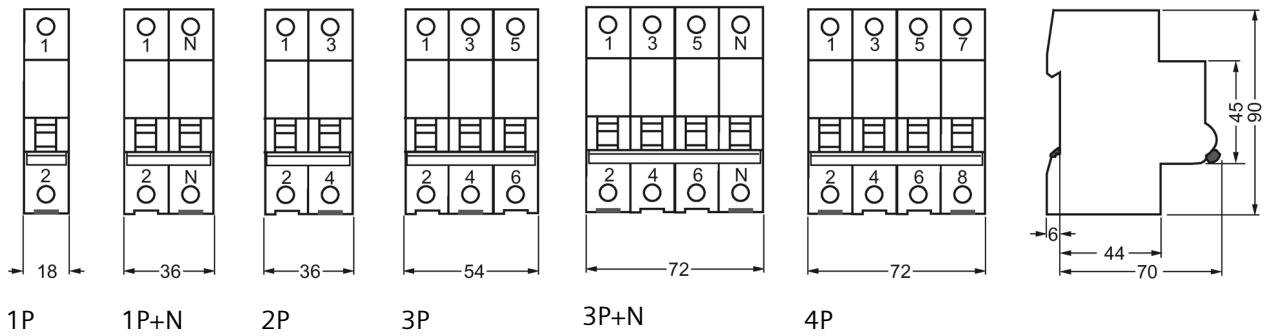

2.5 Graphical symbols

5SL3, 5SL4, 5SL6 (without 5SL30 and 5SL60)



1P



1P+N



2P



3P

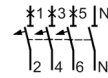

3P+N

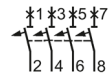

4P

5SY and 5SP miniature circuit breakers

3.1 Overview

MCBs are used to protect systems and installations in buildings and for industrial applications.

Used in industrial applications and plant engineering, miniature circuit breakers can be supplemented with additional components, such as auxiliary switches, fault signal contacts, shunt trips, undervoltage releases, remote controlled mechanisms, RC units, and arc fault detection devices.

The devices are approved for worldwide use according to IEC standards for power supply systems up to 250/440 V AC. 72 V DC per pole is permitted in DC systems.

For North America, there is an additional approval according to UL 1077 for use as "supplementary protectors" in systems up to 480/277 V AC. For use in marine engineering, the devices also have numerous certifications according to marine classifications BV, DNV, GL and LRS. Information on this can be found on the internet.

www.siemens.com/lowvoltage/certificates

3.2 Technical specifications

	Unit	Miniature Circuit Breakers						
		5SY6	5SY4	5SY5	5SY7	5SY8	5SP4	5SP5
Standards								
• IEC / EN 60898-1		✓	✓	--	✓	--	✓	--
• IEC / EN 60898-2		--	--	✓	--	--	--	--
• IEC / EN 60947-2		✓	✓	--	✓	✓	--	✓
• UL 1077		✓	✓	✓	✓	✓	✓	--
Approvals								
• General product approvals		VDE, IMQ, CCC		VDE, CCC	VDE, IMQ, CCC		VDE, CCC	--
								
• Marine classifications		DNV-GL, LR, BV, RINA, ABS		ABS	DNV-GL, LR, BV, RINA, ABS	ABS	LR	--
Rated voltage U_n	V AC	230 / 400		230 / 400	230 / 400	230 / 400	230 / 400	--
	V DC	--		220 / 440 / 880 ⁴⁾	--	--	--	220 / 440
Operational voltage								
	Min.	V AC/DC per pole	24	24	24	24	24	24
Acc. to EN 60898-1/-2 and EN 60947-2	Max.	V DC per pole	72 ³⁾	250	72 ³⁾	72 ³⁾	72	250
	Max.	V AC	250 / 440	250 / 440	250 / 440	250 / 440	250 / 440	--
Acc. to UL 1077 and CSA C22.2 No. 235	Max.	V AC	480 / 277	--	480 / 277	480 / 277	480 / 277	--
	Max.	V DC	60	--	--	--	--	--
Switching capacity (for detailed information, see (Page 81))								
• I _{cn} acc. to IEC/EN 60898-1	kA AC	6	10	10	15	--	10	--
• I _{cn} acc. to IEC/EN 60898-2	kA DC	10		10	15	--	10	--
• I _{cu} acc. to IEC/EN 60947-2 (for detailed information, see (Page 81))	kA AC	30 ... 10	35 ... 10	35 ... 10	50 ... 15	70 ... 20	10	--
	kA DC	15		15	15	15	15	10

	Unit	Miniature Circuit Breakers					
• Acc. to UL1077 and CSA C22.2 No. 235	kA AC	5	--	5	5	5	--
Insulation coordination							
• Rated insulation voltage	V AC	250 / 440					--
	V DC per pole	--	250	--	--	--	250
• Rated impulse voltage U_{imp}	kV	4					
Rated frequency	Hz	50 / 60					--
Pollution degree for overvoltage category		3/III ²⁾					3/III
Touch protection acc. to EN 50274		Yes					
Handle end position, sealable		Yes					
Degree of protection acc. to EN 60529		IP20 with connected conductors, IP40 in the area of the handle with distribution cover					IP20, with connected conductors
CFC and silicone-free		Yes					
Mounting							
• Snap-on fixing system		Yes				--	Yes
• DIN rail and screw fixing		--				Yes	--
Terminals ± screw (Pozidriv)		2					
• Tunnel terminals at both ends		--				Yes	
• Combined terminals at both ends		Yes				--	
• Terminal tightening torque	Nm	2.5 ... 3 (max. 3.5)				2.5 ... 3.5	
	lb/in	22 ... 26				22 ... 31	
Conductor cross-sections							
• Solid and stranded	mm ²	See 5SY conductor cross-sections				See 5SP4 and 5SP5 conductor cross-sections	
• Finely stranded, with end sleeve	mm ²	--					

3.2 Technical specifications

	Unit	Miniature Circuit Breakers		
<ul style="list-style-type: none"> AWG cables (Cu 60/75 °C $I^n \leq 40$ A; 60 °C $I^n > 40$ A) 	AWG	18 ... 4		--
Mains connection				
<ul style="list-style-type: none"> AC 		Any		--
<ul style="list-style-type: none"> DC 		Any	¹⁾	Any
Mounting position		Any		
Vertical device clearance with DIN rails mounted one above the other (grid distance acc. to IEC / DIN EN 60898-1) ⁵⁾	mm	35		140
Service life/endurance on average, with rated load	Actuations	20000 10000 for 5SY5 at 40 A, 50 A and 63 A		10000
Ambient temperature	°C	-25 ... +55, max. 95% humidity	-40 ... +70 ⁶⁾	-25 ... +55, max. 95% humidity
Storage temperature	°C	-40 ... +75 ⁶⁾		
Resistance to climate Acc. to IEC 60068-2-30		6 cycles		--
Shock Acc. to IEC 60068-2-27	m/s ²	150 at 11 ms half-sine		--
Resistance to vibrations Acc. to IEC 60068-2-6	m/s ²	50 at 25 ... 150 Hz and 60 at 35 Hz (4 s)		--
¹⁾ Ensure compliance with the specified polarity when connecting DC. ²⁾ 5SY5 4.. 4-pole, pollution degree 2 for overvoltage category II. ³⁾ Except: C/D 0.3 A ... 0.5 A ⁴⁾ 5SY54.. 4-pole 880 V is not a standardized voltage acc. to EN 60898-1, suitable for max. 1000 V DC if the four poles are connected in series. ⁵⁾ For more explanations and application notes, see Consideration of minimum clearances (Page 99) ⁶⁾ 95% humidity up to max. 55 °C; 55% humidity up to max. 70 °C; 30% humidity up to max. 75 °C				

See also

www.siemens.com/lowvoltage/certificates (www.siemens.com/lowvoltage/certificate)

3.3 Conductor cross-sections

5SY conductor cross-sections (without compact)

Number of connected conductors		Solid ($\leq 10 \text{ mm}^2$) / stranded ($\geq 16 \text{ mm}^2$)		Finely stranded with insulated end sleeve ³⁾		Finely stranded without end sleeve ⁴⁾	
1 conductor at front (+ busbar ²⁾ at rear)	mm ²	0.75 ... 35		0.75 ... 25		1 ... 25	
1 conductor at rear	mm ²	0.75 ... 25		0.75 ... 16		1 ... 16	
2 conductors at front ¹⁾ (+ busbar ²⁾ at rear)	mm ²	0.75 ... 10		0.75 ... 6		1 ... 6	
2 conductors at rear ¹⁾	mm ²	0.75 ... 6		0.75 ... 4		1 ... 4	
1 conductor at front/ 1 conductor at rear	mm ²	f: 0.75 ... 16	r: 0.75 ... 25	f: 0.75 ... 16	r: 0.75 ... 16	f: 1 ... 16	r: 1 ... 16
	mm ²	f: 25	r: 0.75 ... 16	f: 25	r: 0.75 ... 6	f: 25	r: 1 ... 6
	mm ²	f: 35	r: 0.75 ... 10				
1 conductor at front/ 2 conductors at rear ¹⁾	mm ²	f: 0.75 ... 35	r: 0.75 ... 6	f: 0.75 ... 16	r: 0.75 ... 4	f: 1 ... 16	r: 1 ... 4
	mm ²			f: 25	r: 0.75 ... 2.5	f: 25	r: 1 ... 2.5
2 conductors at front ¹⁾ / 1 conductor at rear	mm ²	f: 0.75 ... 10	f: 0.75 ... 25	f: 0.75 ... 6	r: 0.75 ... 16	f: 1 ... 6	r: 1 ... 16
2 conductors at front ¹⁾ / 2 conductors at rear ¹⁾	mm ²	f: 0.75 ... 10	r: 0.75 ... 6	f: 0.75 ... 6	r: 0.75 ... 4	f: 1 ... 6	r: 1 ... 4

- 1) Only conductors of the same cross-section and same conductor type.
- 2) When bus mounting with 5ST36.., 5ST37.. pin busbars, the busbars are connected only in the rear terminal area.
- 3) According to DIN 46228-4:1990, there is no finger-safety when using end sleeves with 18 mm.
- 4) The general installation regulations must be observed; finely stranded conductors must be twisted before being inserted into the terminal; no individual copper fibers are allowed to project after connecting to the terminal.

5SP4 and 5SP5 conductor cross-sections

Number of connected conductors ²⁾		Solid	Stranded	Finely stranded	Finely stranded with end sleeve
1 conductor 2 conductors ¹⁾	mm ²	1.5 ... 10	4 ... 50	4 ... 50	1.5 ... 35

- 1) 2 conductors can be clamped in one terminal only if the conductors have the same cross-section. For 2 conductors, the cross-section of the individual conductors must be halved.
- 2) No bus mounting for anti-slip terminal.

3.4 Dimensional drawings

5SY

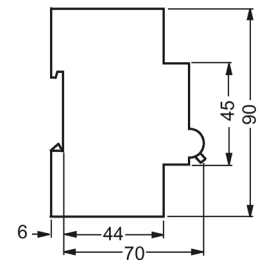
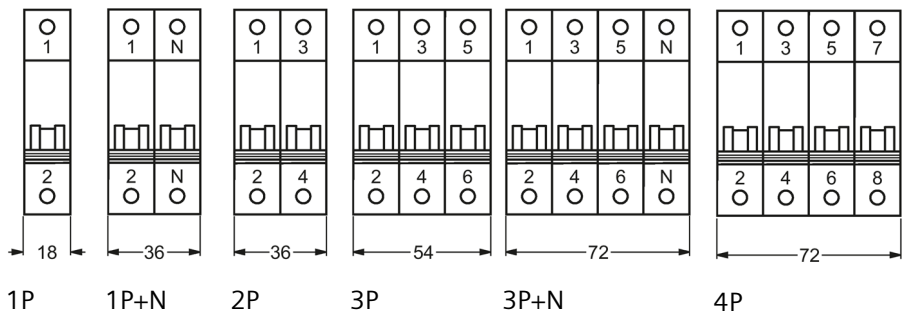

5SP4 and 5SP5

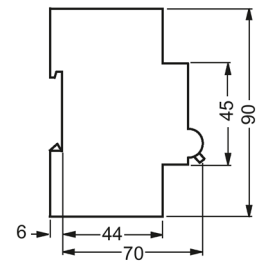
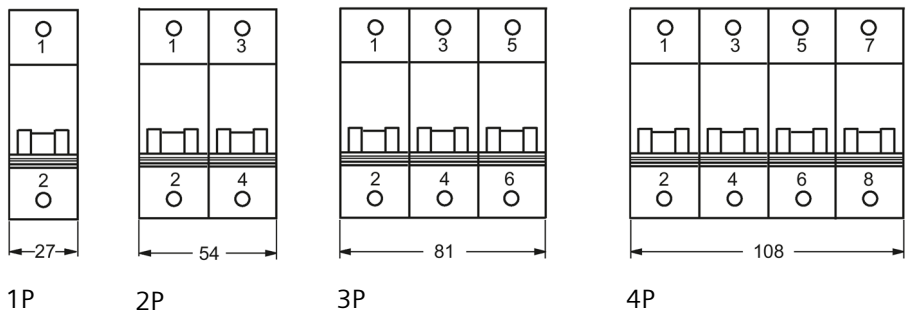

3.5 Graphical symbols

5SY4, 5SY6, 5SY7, 5SY8



1P



1P+N



2P



3P

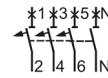

3P+N

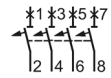

4P

5SP4



1P



2P



3P

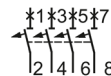

4P

5SY5



1P



2P

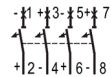

4P

5SL compact miniature circuit breakers, 1+N in 1 MW

4

4.1 Overview

These miniature circuit breakers are used for the protection of systems and installations with switched neutral conductors in distribution boards with little space. They are just a single modular width.

They are suitable for the quick and easy mounting of additional components, such as auxiliary switches and fault signal contacts.

To facilitate cable entry, the devices are equipped with rectangular terminals for the accommodation of pin busbars with cables up to 10 mm². Compact busbars facilitate installation in space-saving distribution boards.

The rated current range is between 2 A and 40 A. The 5SL.0 compact miniature circuit breakers are available in characteristics B and C.

4.2 Technical specifications

	Unit	5SL30..	5SL60..
Standards		IEC / EN 60898-1	
Approvals		see internet (www.siemens.com/lowvoltage/certificates)	
Rated voltage U_n	V AC	230	
Operational voltage			
• Min.	V AC/DC per pole	24	
• Max.	V AC	250	
	V DC per pole	72	
Rated switching capacity I_{cn}	kA AC	4.5	6
Insulation coordination			
• Rated insulation voltage	V AC	250	
• Pollution degree for overvoltage category		2 / III	
Rated frequency	Hz	50 / 60	
Touch protection Acc. to EN 50274		Yes	
Handle end position, sealable		Yes	
Degree of protection Acc. to EN 60259		IP20 with connected conductors, IP40 in the area of the handle with distribution cover	
CFC and silicone-free		Yes	
Mounting position		Any	
Vertical device clearance with DIN rails mounted one above the other (grid distance acc. to IEC/EN 60898-1) ¹⁾	mm	35	
Service life/endurance on average, with rated load		20000 actuations at 2 A/4 A and 40 A: 8000 actuations	
Ambient temperature	°C	-25...45°C: Max. 85% rel. humidity, 45-60°C: Max. 43% rel. humidity	
Storage temperature	°C	-40 ... +75	
Resistance to climate Acc. to IEC 60068-2-30		6 cycles (periodically +55°C, max. 95% rel. humidity)	
Resistance to vibrations Acc. to IEC 60068-2-6	m/s ²	50 at 25 ... 150 Hz and 60 at 35 Hz (4 s)	
¹⁾ For more explanations and application notes, see Consideration of minimum clearances (Page 99)			

4.3 Conductor cross-sections

Conductor cross-sections		
<i>1 conductor</i>		
• Solid/stranded	mm ²	0.75 ... 16
• Finely stranded with non-insulated end sleeve	mm ²	0.75 ... 10
• Finely stranded with insulated end sleeve	mm ²	0.75 ... 10
• Finely stranded without end sleeve	mm ²	0.75 ... 16
<i>2-wire, same cross-section, same conductor type</i>		
• Solid/stranded	mm ²	0.75 ... 4
• Finely stranded with non-insulated end sleeve	mm ²	0.75 ... 2.5
• Finely stranded with insulated end sleeve	mm ²	0.75 ... 1.5
• Finely stranded without end sleeve	mm ²	0.75 ... 4
<i>1 wire + busbar</i>		
• Solid/stranded	mm ²	--
• Finely stranded with non-insulated end sleeve	mm ²	6 ... 10
• Finely stranded with insulated end sleeve	mm ²	6 ... 10
• Finely stranded without end sleeve	mm ²	--

4.4 Dimensional drawings

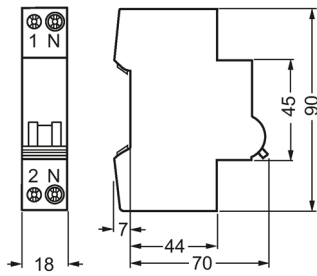

1P+N (N pole, right)

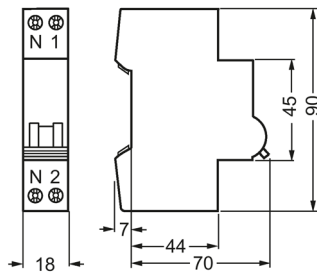

1P+N (N pole, left)

4.5 Graphical symbols



1P+N (N pole, right)



1P+N (N pole, left)

4.5 Graphical symbols

5SL6 COM miniature circuit breakers with communication and measuring function

5

5.1 Overview

The protection devices and auxiliary components with communication capability record measured values and status information, and transfer these wirelessly to data transceivers such as the 7KN Powercenter 1000.

- Recording of active and reactive energy, active, apparent and reactive power, power factor, current, voltage, line frequency and temperature
- Integrated state detection, operating hours counter and trip counter
- Higher system availability through early response to warning messages with limit value monitoring
- Convenient integration into new and existing installations thanks to compact widths of 1+N in 1MW
- Fast parameter assignment und commissioning with the SENTRON powerconfig mobile app or the SENTRON powerconfig software
- Wireless transmission of measured data from up to 24 communication-capable devices to the 7KN Powercenter 1000 data transceiver

Monitoring function with limit value monitoring

- Counters incl. limit value monitoring for:
 - Operating hours
 - Operating hours with load current
 - Operating cycles (ON/OFF)
 - Tripping operations
 - Short circuits
- Limit values for:
 - Overcurrent Alarm 1 and Alarm 2
 - Undercurrent Alarm 1 and Alarm 2
 - Temperature

5.2 Technical specifications

	Unit	5SL60 ... MC
Standards		IEC / EN 60898-1
Approvals		see internet (www.siemens.com/lowvoltage/certificates)
Rated voltage U_n	V AC	230
Operational voltage		
• Min.	V AC	195
• Max.	V AC	253
Rated switching capacity Acc. to EN 60898-1	kA AC	6
Rated current	A	2 to 32
Tripping characteristic classes		B and C
Insulation coordination		
• Rated insulation voltage	V AC	250
• Pollution degree for overvoltage category		2 / III
Rated frequency	Hz	50 / 60
Touch protection Acc. to EN 50274		✓
Handle end position, sealable		✓
Degree of protection Acc. to EN 60529		IP20 with connected conductors IP40 in the area of the handle with distribution cover
CFC and silicone-free		✓
Terminal tightening torque		
• Min.	Nm	1.2
• Max.	Nm	2
Mounting position		Any
Vertical device clearance with DIN rails mounted one above the other (grid distance acc. to IEC/EN 60898-1) ¹⁾	mm	35
Service life/endurance on average, with rated load		7500
Ambient temperature	°C	-25 ... +60 ²⁾
Storage temperature	°C	-40 ... +75
Resistance to climate Acc. to IEC 60068-2-30		6 cycles
¹⁾ For more explanations and application notes, see Consideration of minimum clearances (Page 99) ²⁾ Max. 85% rel. humidity, > 45 °C max. 0.056 kg/m ³ abs. humidity		

Metering and communication functions		
Measured data		Voltage, current, active power, apparent power, reactive power, active energy, line frequency, power factor, temperature, operating cycles, operating hours, tripping operation, warnings
Data transfer to 7KN Powercenter 1000		Radio
Frequency for radio transmission		
• Min.	MHz	2400
• Max.	MHz	2483.5
Radio Equipment Directive		RED 2014/53/EU
Measurement accuracy		
Current	%	+/-0.5
Voltage	%	+/-0.5
Power	%	+/-1
Energy	%	+/-1

5.3 Conductor cross-sections

Conductor cross-sections		
<i>1 conductor</i>		
• Solid/stranded	mm ²	0.75 ... 16
• Finely stranded with non-insulated end sleeve	mm ²	0.75 ... 10
• Finely stranded with insulated end sleeve	mm ²	0.75 ... 10
• Finely stranded without end sleeve	mm ²	0.75 ... 16
<i>2-wire, same cross-section, same conductor type</i>		
• Solid/stranded	mm ²	0.75 ... 4
• Finely stranded with non-insulated end sleeve	mm ²	0.75 ... 2.5
• Finely stranded with insulated end sleeve	mm ²	0.75 ... 1.5
• Finely stranded without end sleeve	mm ²	0.75 ... 4
<i>1 wire + busbar</i>		
• Solid/stranded	mm ²	--
• Finely stranded with non-insulated end sleeve	mm ²	6 ... 10
• Finely stranded with insulated end sleeve	mm ²	6 ... 10
• Finely stranded without end sleeve	mm ²	--

5.4 Dimensional drawings

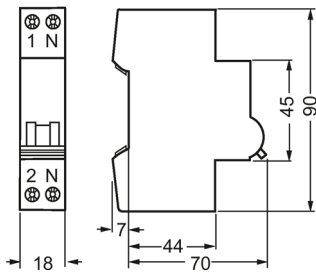

1P+N (N pole, right)

5.5 Graphical symbols

5.5 Graphical symbols



1P+N (N pole, right)

5SJ6...-.KS miniature circuit breakers, with plug-in terminals

6

6.1 Overview

Miniature circuit breakers with plug-in terminals are used for the protection of socket outlets and lighting circuits with the most common rated currents of 10 to 20 A.

6.2 Technical specifications

	Unit	5SJ6 ... - . KS
Standards		IEC / EN 60898-1
Approvals		see internet (www.siemens.com/lowvoltage/certificates)
Rated voltage U_n	V AC	230 / 400
Operational voltage		
• Min.	V AC/DC per pole	24
• Max.	V AC	250 / 440
	V DC per pole	60 ¹⁾
Rated switching capacity Acc. to EN 60898-1	kA AC	6
Insulation coordination		
• Rated insulation voltage	V AC	250 / 440
• Pollution degree for overvoltage category		2 / III
Rated frequency	Hz	50 / 60
Touch protection Acc. to EN 50274		Yes
Handle end position, sealable		Yes
Degree of protection Acc. to EN 60529		IP20 with connected conductors, IP40 in the area of the handle with distribution cover
CFC and silicone-free		Yes
Terminals		Screwless terminals on the outgoing terminals for 1.5 ... 4 mm ²
Mounting position		Any
Vertical device clearance with DIN rails mounted one above the other (grid distance acc. to IEC/EN 60898-1) ²⁾	mm	35
Service life/endurance on average, with rated load		20000 actuations
Ambient temperature	°C	-25 ... +45, occasionally +55, max. 95% humidity
Storage temperature	°C	-40 ... +75
Resistance to climate Acc. to IEC 60068-2-30		6 cycles
¹⁾ The operational voltage of 60 V DC per pole takes into account a battery charging voltage with a peak value of 72 V. ²⁾ For more explanations and application notes, see Consideration of minimum clearances (Page 99)		

6.3 Conductor cross-sections

Conductor cross-sections		
<i>Top, plug-in terminals</i>		
<ul style="list-style-type: none"> Solid, stranded and finely stranded, without end sleeve 	mm ²	1.5 ... 4
<ul style="list-style-type: none"> Finely stranded, with end sleeve 	mm ²	1.5 ... 2.5
<i>Bottom, tunnel terminal</i>		
<ul style="list-style-type: none"> Solid, stranded or finely stranded, with end sleeve 	mm ²	Bolt (Pozi driv) 2 0.75 ... 25

6.4 Dimensional drawings

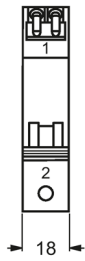

1P



1P+N

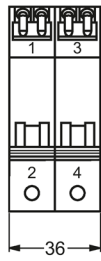

2P



3P

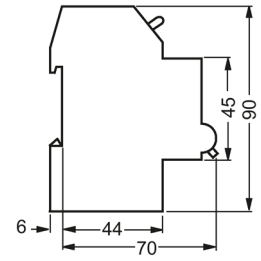

6.5 Graphical symbols



1P



1P+N



2P



3P

Additional components

7.1 Overview

The Siemens mounting concept supports the combination of all 5ST3 additional components with Siemens 5SY and 5SP miniature circuit breakers and with 5SU1 RCBOs. 5SL and 5SL30/60 miniature circuit breakers are suitable for mounting auxiliary switches and fault signal contacts. Auxiliary switches can also be mounted on 5TE8 flush-mounting circuit breakers and 5SG71 MINIZED switch disconnectors.

Auxiliary switches (AS)

The auxiliary switch (AS) always signals the contact position of the miniature circuit breaker, regardless of whether the miniature circuit breaker was tripped manually or as the result of a fault. An additional version is also available for the switching of small currents and voltages for the control of programmable logic controllers (PLCs) according to EN 61131-2. The auxiliary switch with test button enables the testing of control circuits without the need to switch the miniature circuit breaker.

Fault signal contacts (FC)

The fault signal contact (FC) signals the automatic tripping of the miniature circuit breaker in the event of a fault, such as an overload or a short-circuit. If the fault signal contact is activated, the contact position does not change if the miniature circuit breaker is tripped manually. Fault signal contacts with TEST and RESET buttons enable the testing of control circuits without the need to trip the miniature circuit breaker. The red RESET button integrated in the handle also indicates the automatic tripping of the MCB. The signal can be acknowledged manually using the RESET button.

Auxiliary switch and fault signal contact (AS+FC)

The 5ST3062 combined auxiliary switch and fault signal contact in MW 0.5 combines the functions of the AS (5ST301.) and FC (5ST302.) auxiliary functions in one device. Here, 2 changeover contacts are installed in the device. When in use, this takes up 50% less space than the conventional accessory combination of AS and FC.

5ST3 COM auxiliary switches / fault signal contacts (AS+FC) with communication and measuring function

The 5ST3 COM auxiliary switch / fault signal contact in MW 0.5 combines the AS and FC auxiliary components and supplements them with a communication and measuring function.

It measures the device temperature and the switching status of the mounted protection device (switched on, switched off manually, tripped, tripped with locked handle). It also counts operating cycles, operating hours and the number of tripping operations.

The measured data of up to 24 communication-capable circuit protection devices are transmitted wirelessly to the 7KN Powercenter 1000 data transceiver and parameterized and visualized via the SENTRON powerconfig software/app.

The double plug-in terminals of the 24V DC power supply enable a simple loop-through (daisy chain) of the voltage.

Shunt trips (ST)

Shunt trips are used for the remote tripping of a miniature circuit breaker.

Undervoltage releases (UR)

Undervoltage releases are integrated for example into EMERGENCY OFF loops, thus ensuring that the MCB trips in the event of an emergency. EMERGENCY OFF is an action that is intended to switch off the electrical power supply to all or parts of the installation in the event of an emergency where there is the danger of electric shock or some other danger caused by electrical power.

In addition, an undervoltage release trips if the voltage is interrupted or too low, or prevents the miniature circuit breaker from closing.

Remote controlled mechanisms (RC mech.)

Remote controlled mechanisms are used for the remote (ON/OFF) switching of our protection components such as miniature circuit breakers, residual current operated circuit breakers or their derivatives. They also enable local manual switching. A blocking function permits maintenance work (not for variants without a mode selector switch).

In the event of local manual switch-off, remote switching is only possible again after local manual switch-on. The remote controlled mechanism has a mode selector switch with the functions: "OFF", "RC OFF" and "RC ON".

Note

The 5ST3053 BASIC variant has no mode selector switch, and the 5ST3054 BASIC variant does not have the "RC OFF" switch position.

Brief explanation of the modes available for selection:

- OFF: The remote controlled mechanism is switched off, blocked mechanically and can be sealed and/or locked by means of an accessory lock. This mode selector position is possible only in the switched off state of the device.
- RC OFF: Only manual operation is possible. No mechanical blocking of the remote controlled mechanism. Remote switching operations are not possible.
- RC ON: Both manual and remote operation are possible. Remote switching is only possible after the device has been switched on manually once (Manual ON). If the device is switched off manually, it must be switched on again manually. This ensures safety during commissioning/maintenance of the installation.

In an RC unit/miniature circuit breaker combination, the RC unit is switched on asynchronously, i.e. prior to the miniature circuit breaker. The RC units for 5SY and 5SL can be switched ON via the optionally available adapters. There is no need to switch off the RC unit via the remote controlled mechanism as the MCB contacts ensure disconnection of the electrical circuit.

The switching frequency is max. 3 actuations per minute. More additional 5ST3 ... components, such as AS, FC, ST and UR, can be added to the right-hand side of the remote controlled mechanism in line with the Siemens mounting concept.

7.1 Overview

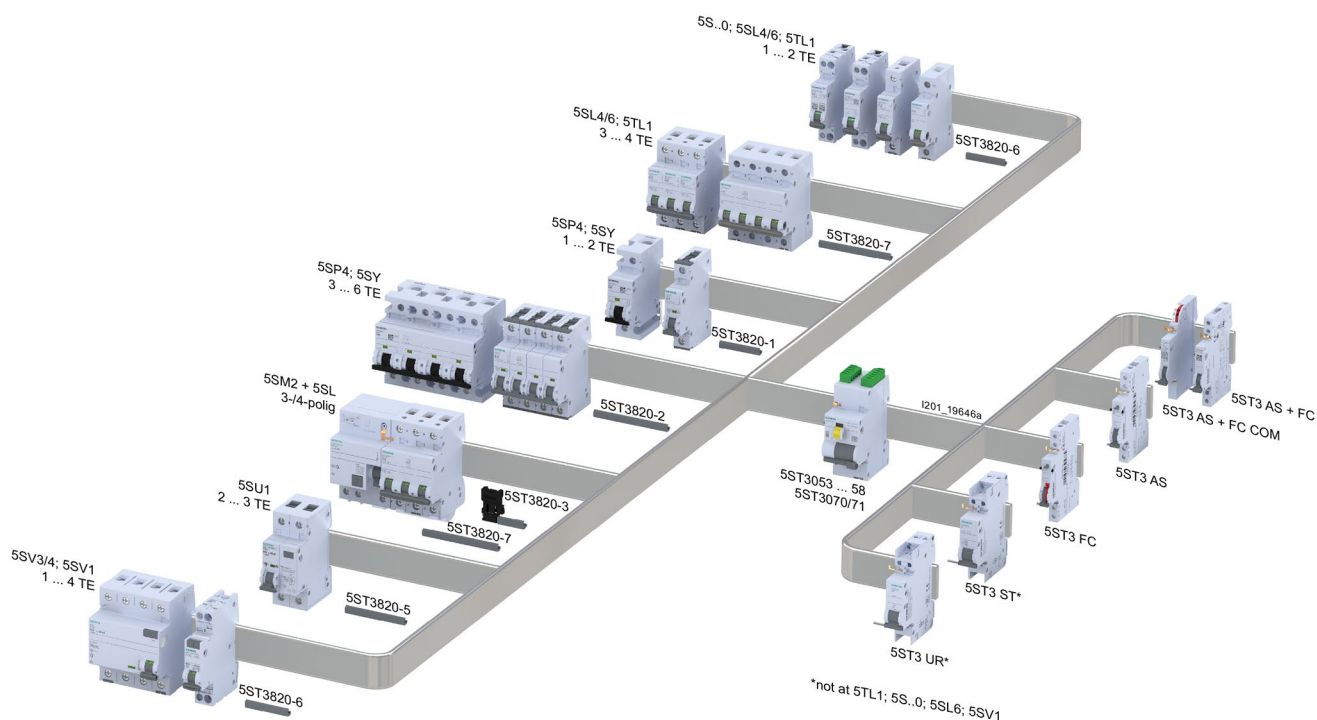

RC units

RC units can be combined with miniature circuit breakers of characteristic A, B, C and D. They then form a combination of RCCB and MCB for personnel, fire and line protection. The combinations can be tailored to meet individual requirements. You can find information about RC units on the internet (www.siemens.com/lowvoltage/certificates).

7.2 Technical specifications

7.2.1 Technical specifications for auxiliary switches (AS)

	Unit	Auxiliary switches (AS)				
		5ST3010 5ST3011 5ST3012 5ST3016	5ST3010-0HG 5ST3011-0HG 5ST3012-0HG	5ST3010-2 5ST3011-2 5ST3012-2	5ST3013 5ST3014 5ST3015 5ST3013-0XX01 ¹⁾	5ST3013-2 5ST3014-2 5ST3015-2
Standards		IEC / EN 62019, IEC / EN 60947-5-1	--	IEC / EN 62019, IEC / EN 60947-5-1		
		UL 1077, CSA C22.2 No. 235	UL 489, CSA 22.2 No. 5-02	--	UL 1077	--
Approvals		see internet (www.siemens.com/lowvoltage/certificates)				
Short-circuit protection		5SY ... 6 A miniature circuit breaker or gG 6 A fuse				
Contact load						
• Min.		50 mA, 24 V			1 mA, 5 V DC	5 mA, 5 V DC
• Max.		--			100 mA, 30 V DC	50 mA, 30 V DC
<i>Acc. to IEC/EN 62019; IEC/EN 60947-5-1</i>						
• 230 V AC, AC-12	A	--				
• 230 V AC, AC-13	A	6 / 6			--	
• 400 V AC, AC-13	A	2 / 2			--	
• 230 V AC, AC-1	A	6 / 6			--	
• 400 V AC, AC-14	A	2 / 2			--	
• 24 V DC, DC-13	A	6 / 3			--	
• 30 V DC, DC-14	A	--			0.1	
• 60 V DC, DC-13	A	3 / 1.5			--	
• 110 V DC, DC-13	A	1 / 0.75			--	
• 220 V DC, DC-12	A	--			--	
• 220 V DC, DC-13	A	1 / 0.5			--	
<i>Acc. to UL</i>						
• 120 V AC	A	--	6	--		
• 125 V AC	A	3	--			
• 240 V AC	A	4	--			
• 277 V AC	A	--	3	--		

	Unit	Auxiliary switches (AS)		
• 480 V AC	A	1.5		--
• 60 V DC	A	--	3	--
• 125 V DC	A	1.1	1	--
• 250 V DC	A	0.55	--	
Service life/endurance, on average, with rated load		20000 actuations	12000 actuations	20000 actuations
Conductor cross-sections	mm ²	0.5 ... 2.5		
	AWG	22 ... 14		
Terminals				
Terminal tightening torque	Nm	0.5		
	lb/in	4.5		
Rated frequency	Hz	50 / 60		
Mounting position		Any		
Ambient temperature	°C	-40 ... +70		
Storage temperature	°C	-40 ... +75		
Resistance to climate Acc. to IEC 60068-2-30	Cycles	28		
Shock Acc. to IEC 60068-2-27	m/s	150 at 11 ms half-sine		
Resistance to vibrations Acc. to IEC 60068-2-6	m/s ²	50 at 10 ... 150 Hz		

1) No approvals

See also

Internet. (<https://support.industry.siemens.com/cs/ww/en/view/109750639>)

7.2.2 Technical specifications for fault signal contacts (FC)

	Unit	Fault signal contacts (FC)		
		5ST3020 5ST3021 5ST3022	5ST3020-2 5ST3021-2 5ST3022-2	5ST3020-0HG 5ST3021-0HG 5ST3022-0HG
Standards		IEC / EN 62019, IEC / EN 60947-5-1		
		UL 1077, CSA C22.2 No. 235	--	UL 489, CSA 22.2 No. 5-02
Approvals		see internet (www.siemens.com/lowvoltage/certificates)		
Short-circuit protection		Miniature circuit breaker or gG 6 A fuse		
Contact load				
• Min.		50 mA, 24 V		
• Max.		--		
<i>Acc. to IEC / EN 62019; IEC / EN 60947-5-1</i>				
• 230 V AC, AC-13	A	6 / 6		
• 400 V AC, AC-13	A	6 / 6		
• 230 V AC, AC-14	A	2 / 2		
• 400 V AC, AC-14	A	2 / 2		
• 24 V DC, DC-13	A	6 / 3		
• 60 V DC, DC-13	A	3 / 1.5		
• 110 V DC, DC-13	A	1 / 0.75		
• 220 V DC, DC-13	A	1 / 0.5		
<i>Acc. to UL</i>				
• 120 V AC	A	--		6
• 125 V AC	A	3	--	
• 240 V AC	A	4	--	
• 277 V AC	A	--		3
• 480 V AC	A	1.5	--	
• 60 V DC	A	--		3
• 125 V DC	A	1.1	--	1
• 250 V DC	A	0.55	--	
Service life/endurance, on average, with rated load		20000 actuations		12000 actuations
Conductor cross-sections	mm ²	0.5 ... 2.5		
	AWG	22 ... 14		
Terminals				

7.2 Technical specifications

	Unit	Fault signal contacts (FC)
Terminal tightening torque	Nm	0.5
	lb/in	4.5
Rated frequency	Hz	50 / 60
Mounting position		Any
Ambient temperature	°C	-25 ... +55
Storage temperature	°C	-40 ... +75
Resistance to climate Acc. to IEC 60068-2-30	Cycles	28
Shock Acc. to IEC 60068-2-27	m/s	150 at 11 ms half-sine
Resistance to vibrations Acc. to IEC 60068-2-6	m/s ²	50 at 10 ... 150 Hz

7.2.3 Technical specifications for auxiliary switches (AS) + fault signal contacts (FC)

	Unit	Auxiliary switches (AS) + fault signal contacts (FC)
		5ST3062
Standards		IEC / EN 62019, IEC / EN 60947-5-1 UL 1077, CSA C22.2 No. 235
Approvals		see internet (www.siemens.com/lowvoltage/certificates)
Short-circuit protection		Miniature circuit breaker or gG 6 A fuse
Contact load		
• Min.		50 mA, 24 V
• Max.		--
<i>Acc. to IEC / EN 62019; IEC / EN 60947-5-1</i>		
• 230 V AC, AC-13	A	6 / 6
• 400 V AC, AC-14	A	2 / 2
<i>Acc. to IEC / EN 62019; IEC / EN 62019; IEC / EN 60947-5-1</i>		
• 24 V DC, DC-13	A	3 / 3
• 60 V DC, DC-13	A	3 / 1
• 110 V DC, DC-13	A	0.5 / 0.5
• 220 V DC, DC-13	A	0.5 / 0.3
<i>Acc. to UL</i>		
• 125 V AC	A	2
• 240 V AC	A	1.5
• 480 V AC	A	0.75
• 125 V DC	A	0.5
• 250 V DC	A	0.3
Service life/endurance, on average, with rated load		20000 actuations
Conductor cross-sections	mm ²	0.5 ... 2.5
	AWG	22 ... 14
Terminals		
Terminal tightening torque	Nm	0.5
	lb/in	4.5
Rated frequency	Hz	50 / 60
Mounting position		Any
Ambient temperature	°C	-25 ... +55
Storage temperature	°C	-40 ... +75
Resistance to climate	Cycles	28
<i>Acc. to IEC 60068-2-30</i>		

Additional components

7.2 Technical specifications

	Unit	Auxiliary switches (AS) + fault signal contacts (FC)
Shock Acc. to IEC 60068-2-27	m/s	150 at 11 ms half-sine
Resistance to vibrations Acc. to IEC 60068-2-6	m/s ²	50 at 10 ... 150 Hz

7.2.4 Technical specifications for 5ST3 COM auxiliary switches / fault signal contacts with communication and measuring function

	Unit	5ST3 COM auxiliary switches / fault signal contacts with communication and measuring function 5ST3062-0MC
Standards		IEC / EN 60669-2-5; RED 2014/53/EU
Approvals		see internet (www.siemens.com/lowvoltage/certificates)
Service life/endurance, on average, with rated load		10000 actuations
Supply voltage	V	24 V DC SELV
Conductor cross-sections	mm ²	0.2 ... 1.5
	AWG	24 ... 16
Terminals		Plug-in
Mounting position		Any
Ambient temperature	°C	-25 ... +60
Storage temperature	°C	-40 ... +85
Resistance to climate Acc. to IEC 60068-2-30	Cycles	28
Shock Acc. to IEC 60068-2-27	m/s	150 at 11 ms half-sine
Resistance to vibrations Acc. to IEC 60068-2-6	m/s ²	50 at 10 ... 150 Hz
Rated frequency	Hz	50 / 60
Measured data		Switching status, temperature, operating cycles, operating hours, number of tripping operations, warnings in the event of upper limit violation
Data transfer to 7KN Powercenter 1000		Radio
Frequency for radio transmission	MHz	Min. 2400 MHz Max. 2483.5 MHz

7.2.5 Technical specifications for shunt trips (ST)

	Unit	Shunt trips (ST)				
		5ST3030	5ST3031	5ST3031-0XX01	5ST3030-0HG	5ST3031-0HG
Standards		IEC / EN 60947-1			IEC / EN 60947-1	
		--			UL 489, UL File E321559, CSA 22.2 No. 5-02	
Rated voltages U_n	V AC	230	--	--	110 ... 415	24 ... 48
	V DC	--	110	24	110 ... 220	24 ... 48
Operating range U_n		0.7 ... 1.1 x U_n				
Rated frequency f_n	Hz	50 / 60		--	50 / 60	
Short-circuit protection		BIC 6 A miniature circuit breaker or gG 6 A fuse				
Contact load						
• Min.		50 mA, 24 V		1 mA, 5 V	50 mA, 24 V	
• Max.		--				
Service life/endurance, on average, with rated load		20000 actuations			12000 actuations	
Conductor cross-sections	mm ²	0.5 ... 2.5				
	AWG	22 ... 14				
Terminals						
Terminal tightening torque	Nm	0.8				
	lb/in	6.8				
Mounting position		Any				
Ambient temperature	°C	-25 ... +55		-40 ... +70	-25 ... +55	
Storage temperature	°C	-40 ... +75				
Resistance to climate Acc. to IEC 60068-2-30	Cycles	28				
Shock Acc. to IEC 60068-2-27	m/s	150 at 11 ms half-sine				
Resistance to vibrations Acc. to IEC 60068-2-6	m/s ²	50 at 10 ... 150 Hz				

7.2.6 Technical specifications for undervoltage releases (UR)

	Unit	Undervoltage releases (UR) 5ST304.
Standards		IEC / EN 60947-1
Rated voltages U_n	V AC	230
	V DC	24.110
Operating range U_n		0.85 ... 1.1 x U_n
Rated frequency f_n	Hz	--
Response limits		
Tripping		< 0.35 ... 0.7 x U_n
Short-circuit protection		B/C 6 A miniature circuit breaker or gG 6 A fuse
Minimum contact load		50 mA, 24 V
Tripping operations		Max. 2000
Service life/endurance, on average, with rated load		20000 actuations
Conductor cross-sections	mm ²	0.5 ... 2.5
	AWG	22 ... 14
Terminals		
Terminal tightening torque	Nm	0.8
	lb/in	6.8
Mounting position		Any
Ambient temperature	°C	-25 ... +55
Storage temperature	°C	-40 ... +75
Resistance to climate Acc. to IEC 60068-2-30	Cycles	28
Shock Acc. to IEC 60068-2-27	m/s	150 at 11 ms half-sine
Resistance to vibrations Acc. to IEC 60068-2-6	m/s ²	50 at 10 ... 150 Hz

7.2.7 Technical specifications for remote controlled mechanisms (RC mech.)

	Unit	Remote controlled mechanisms (RC mech.)			
		5ST3053 5ST3055 5ST3057	5ST3054 5ST3056 5ST3058	5ST3070	5ST3071
Standards		EN 50557 (VDE 0640-20)			
Rated voltages U_n	V AC	12 ... 30	177 ... 270	12 ... 30	170 ... 277
	V DC	12 ... 48	--	12 ... 48	77 ... 286
Operating range U_n		0.9 ... 1.15 x U_n			
Rated frequency f_n	Hz	50 / 60			
Response limits					
Tripping		--			
Short-circuit protection		B/C 6 A miniature circuit breaker or gG 6 A fuse			
Minimum contact load		--			
Tripping operations		--			
Service life/endurance, on average, with rated load		10000 actuations			
Conductor cross-sections	mm ²	0.5 ... 1.5			
	AWG	14 ... 30			
Terminals					
Terminal tightening torque	Nm	0.2 ... 0.25			
	lb/in	2.0			
Mounting position		Any			
Ambient temperature	°C	-25 ... +45		-40 ... +70	
Storage temperature	°C	-40 ... +55		-40 ... +70	
Switching frequency		3 actuations per minute			
Switching duration	s	< 2			
Minimum command duration	s	0.2 continuous command possible			
Rated power dissipation	VA	≤ 1			
Behavior in the event of control voltage failure		No change			
Vibration and shock requirements Acc. to EN 61373 / EN 50155		Category 1, Class B			

Technical specifications for the RC units can be found on the internet
<https://support.industry.siemens.com/cs/ww/en/view/109750639>

7.3 Dimensional drawings

7.3.1 Dimensional drawings for auxiliary switches (AS)

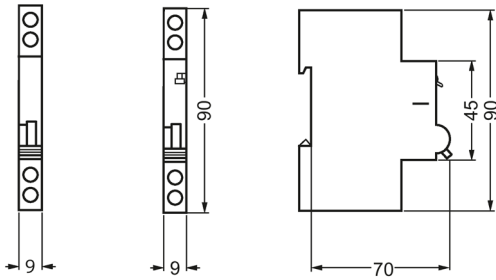

5ST3010	5ST3010-2	5ST3020-2
5ST3011	5ST3011-2	5ST3021-2
5ST3012	5ST3012-2	5ST3022-2
5ST3013	5ST3013-2	
5ST3014	5ST3014-2	
5ST3015	5ST3015-2	
5ST3016		

7.3.2 Dimensional drawings for fault signal contacts (FC)

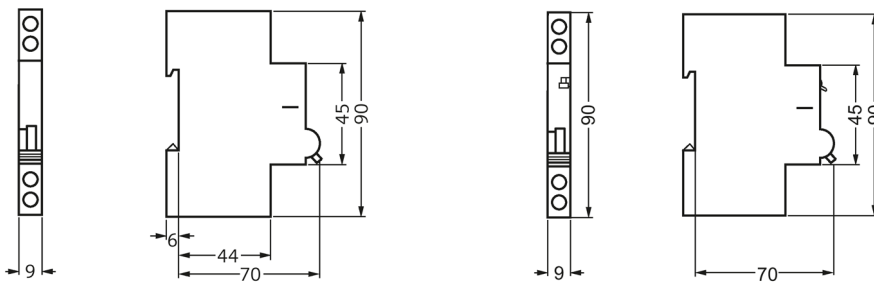

5ST3020	5ST3020-2
5ST3021	5ST3021-2
5ST3022	5ST3022-2

7.3.3 Dimensional drawings for auxiliary switches (AS) + fault signal contacts (FC)

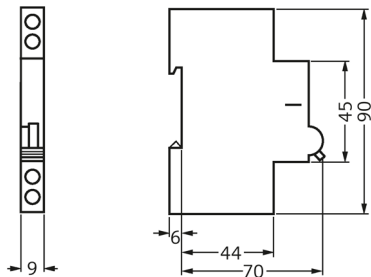

5ST3062

7.3.4 Dimensional drawings for 5ST3 COM auxiliary switches / fault signal contacts with communication and measuring function

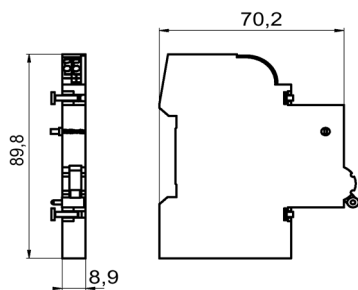

5ST3062-OMC

7.3.5 Dimensional drawings for shunt trips (ST)

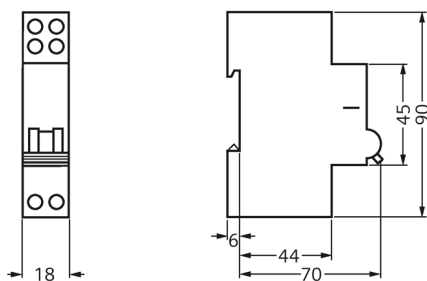

5ST3030
5ST3031
5ST3031-
0XX01

7.3.6 Dimensional drawings for undervoltage releases (UR)

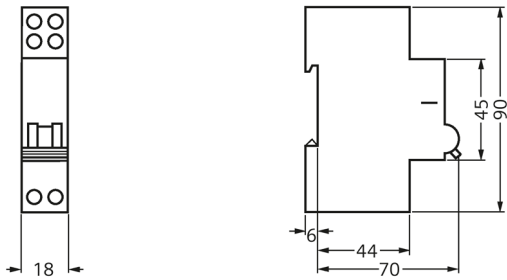

- 5ST3040
- 5ST3041
- 5ST3042
- 5ST3043
- 5ST3044
- 5ST3045

7.3.7 Dimensional drawings for remote controlled mechanisms (RC mech.)

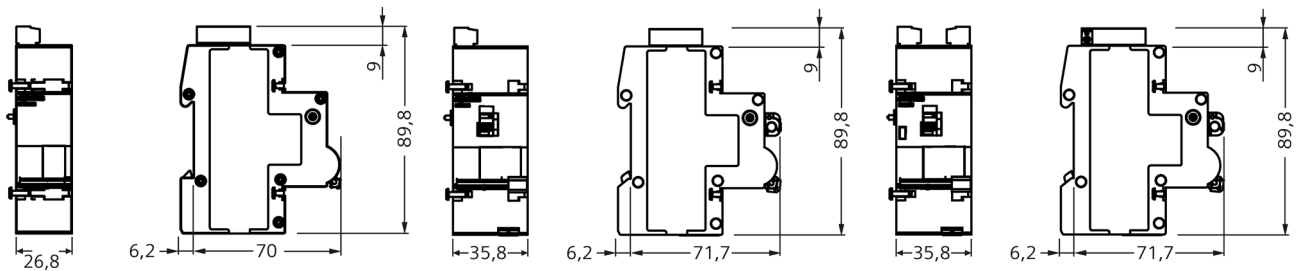

5ST3053

5ST3054

- 5ST3055
- 5ST3056
- 5ST3057
- 5ST3058
- 5ST3070
- 5ST3071

7.3.8 Dimensional drawings

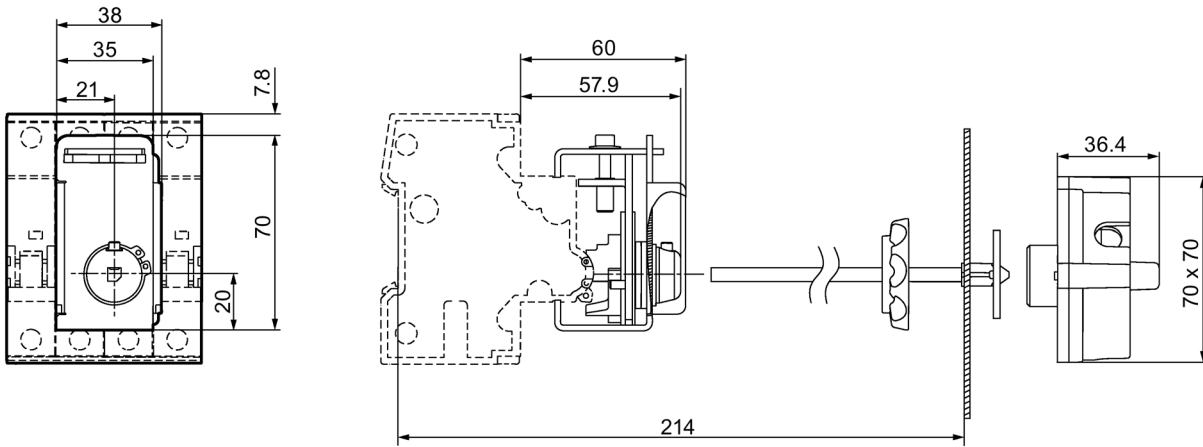

5ST3060
5ST3061

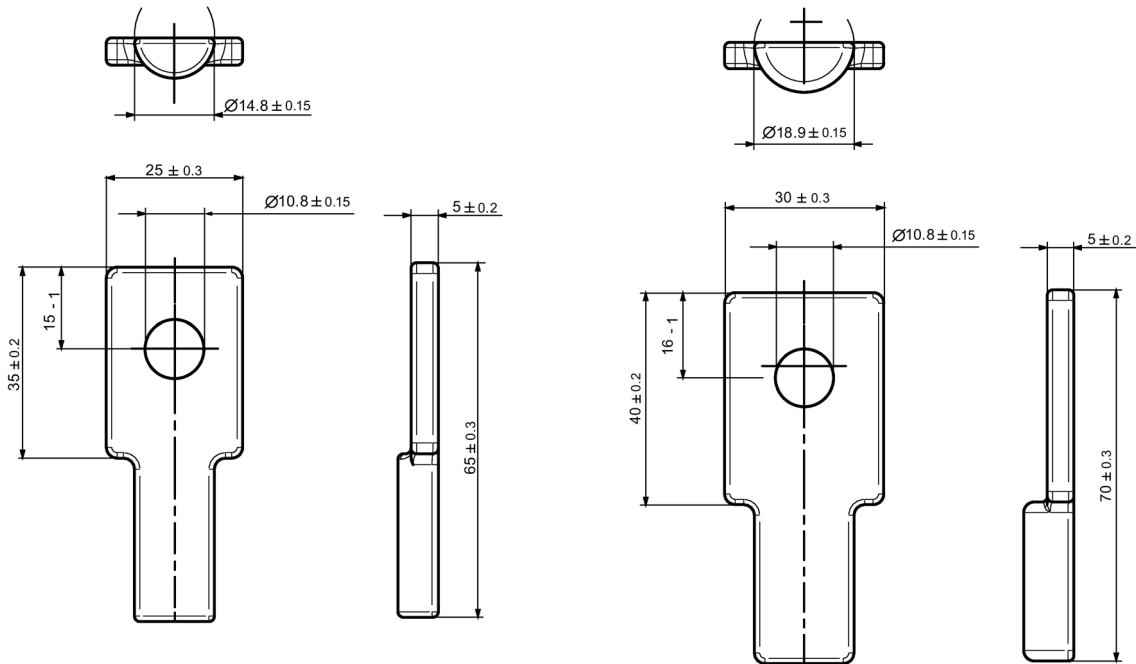

5ST2510

5ST2512

7.4 Graphical symbols

Auxiliary switches (AS)



5ST3010	5ST3011	5ST3012	5ST3016
5ST3013	5ST3014	5ST3015	
5ST3010-2	5ST3011-2	5ST3012-2	

Fault signal contacts (FC)



5ST3020	5ST3021	5ST3022
5ST3020-2	5ST3021-2	5ST3022-2

Auxiliary switches / fault signal contacts (AS+FC)

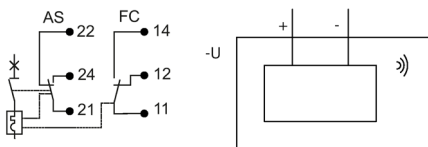

5ST3062	5ST3062-0MC
---------	-------------

Shunt trips (ST)

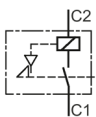

5ST3030
5ST3031
5ST3031-0XX01

Undervoltage releases (UR)

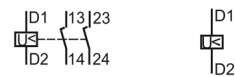

5ST3040	5ST3043
5ST3041	5ST3044
5ST3042	5ST3045

7.4 Graphical symbols

Remote controlled mechanisms (RC mech.)

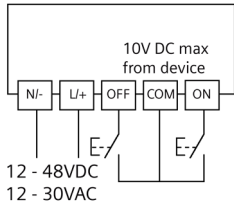

5ST3053

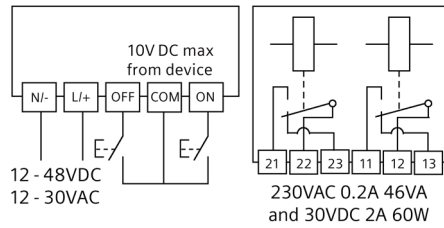

5ST3055
5ST3057
5ST3070

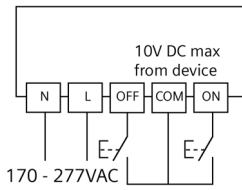

5ST3054

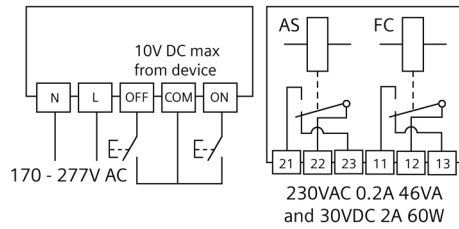

5ST3056
5ST3058

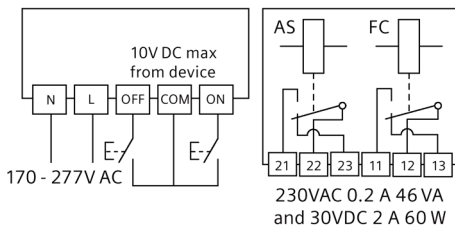

5ST3071

7.5 More information

The Siemens mounting concept supports the combination of all 5ST3 additional components with miniature circuit breakers of the 5SY, 5SP4/5 and 5SL4 series and RCBOs of the 5SU1 series. The 5SL miniature circuit breakers is suitable for mounting auxiliary switches and fault signal contacts. Auxiliary switches can also be mounted on 5TE8 flush-mounting circuit breakers and 5SG71 MINIZED switch disconnectors. The diagram shows which additional components can be mounted on either the right or the left.

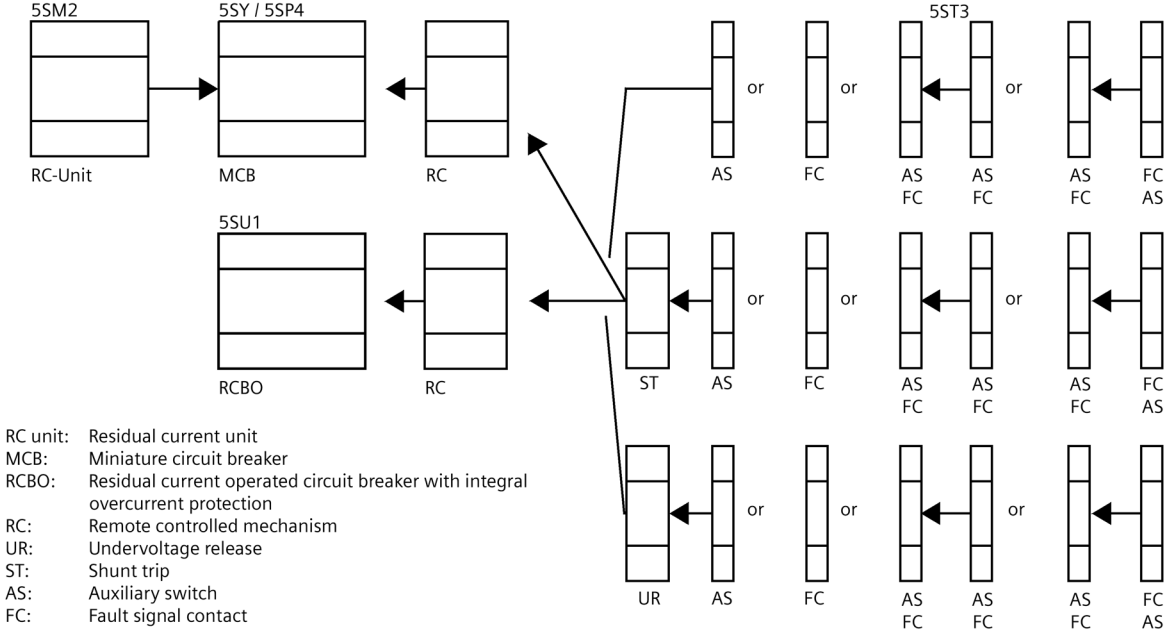

The mounting concept for RCBOs can be found on the internet.
<https://support.industry.siemens.com/cs/ww/en/view/109750639>

Busbars

8.1 5ST standard busbars

8.1.1 Overview

The busbar system with pin-type connections can be used for all 5SL, 5SJ6... - .KS and 5SY miniature circuit breakers with or without mounted auxiliary switch (AS) or fault signal contact (FC).

Busbars in 10 mm² and 16 mm² versions are available.

With bars that can be cut to length, the 5ST37 busbar system can be tailored to any requirements.

The extremely flexible 5ST36 busbar system with fixed lengths also enables installation in any length as the busbars can be overlapped.

There is no further need for time-consuming tasks, such as cutting, cutting to length, deburring, cleaning of cut surfaces and mounting of end caps.

Any free pins on the busbars can be made safe by covering with touch protection. For further information on the bus-mounting of miniature circuit breakers with residual current operated circuit breakers, see section "Residual Current Protective Devices / Arc Fault Detection Devices (AFDDs)" in Catalog LV 10 (<https://support.industry.siemens.com/cs/ww/en/view/109482234>).

8.1.2 Technical specifications

	Unit	Busbar
		5ST3
Standards		EN 60439-1 (VDE 0660-500): 2005-01
Busbar material		SF-Cu F 24
Partition material		Plastic Cycoloy 3600, heat-resistant above 90 °C, flame-retardant, self-extinguishing, free of dioxins and halogens
Rated operational voltage U_c	V AC	400
Rated current I_n		
• Cross-section 10 mm ²	A	63
• Cross-section 16 mm ²	A	80
Rated impulse withstand voltage U_{imp}	kV	4
Test pulse voltage (1.2/50)	kV	6.2
Rated conditional short-circuit current I_{cc}	kA	25
Resistance to climate		
Constant atmosphere acc. to DIN 50015		23 / 83; 40 / 92; 55 / 20
Humid heat acc. to IEC 60068-2-30		28 cycles
Insulation coordination		
Overtoltage category		III
Pollution degree		2
Maximum busbar current I_s/phase		
<i>Infeed at the start of the busbar</i>		
• Cross-section 10 mm ²	A	63
• Cross-section 16 mm ²	A	80
<i>Infeed at the center of the busbar</i>		
• Cross-section 10 mm ²	A	100
• Cross-section 16 mm ²	A	130

Infeed at the start or end of the busbar

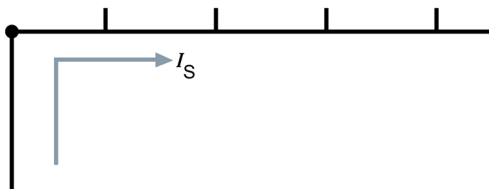

Infeed along the busbar or midpoint infeed

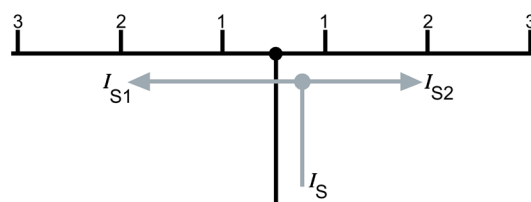

The sum of the outgoing current per branch (1, 2, 3 ... n) must not be greater than the max. busbar current I_s /phase.

8.2 Compact busbars

Overview

The new compact busbar system can be used for all compact devices (1+N in 1 MW) and combinations thereof (e.g. AFD unit with mounted 5SL60 compact miniature circuit breaker). There are also compact busbars for basic devices with a mounted auxiliary switch or fault signal contact or with an upstream residual current operated circuit breaker.

The compact busbars can also be used for the 5SV1 compact RCBOs.

The special feature of the compact busbars is the possibility to feed in or wire further through the bar. To this end, you can wire directly through the bar into the clamping point of the basic device or, in the case of larger cross-sections, by means of a conventional infeed terminal.

The busbar system is available in various prefabricated lengths. 5ST36 covers most standard applications in this case. 5ST37 busbars are usually shortened according to the application. All busbars can be cut.

All of the busbars have a cross-section of 10 mm².

Any free pins on the busbars can be made safe by covering with touch protection. Please use the 5ST3655 cover for L1 and N, and the 5ST3655-0HG cover for L2 / L3.

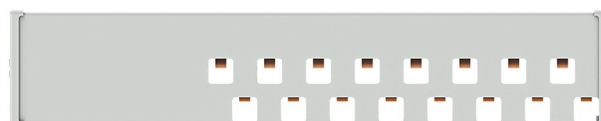
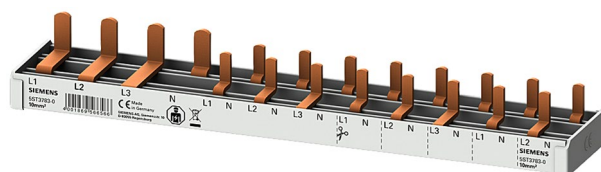

8.3 Busbars according to UL508, 5ST3

8.3.1 Overview

Products according to UL standards are used in North America, but also in several other countries. This is important in particular for exporting machines or electrical switchboard assemblies and equipment to the USA. Acceptance and delivery are possible only if the relevant UL standards are satisfied.

The 5ST37 busbar system according to UL 508 and CSA is suitable for both universal use worldwide with all 5SY and 5SP miniature circuit breakers for "Supplementary Protection" certified according to UL 1077 and for 3NW and 3NC fuse holders certified according to UL 512. Not approved for use in feeder circuits.

The busbars are available in 1-, 2- and 3-phase versions with different pin spacings and with two cross-sections 18 mm² and 25 mm². Infeed can be directly into the terminals of the miniature circuit breaker or through connection terminals.

The connection terminals are available in two versions – for direct infeed at the busbar or for infeed directly at the miniature circuit breaker/fuse holder. Pins that are not required can be covered with touch protection covers.

8.3.2 Technical specifications

	Unit	Busbar			
		5ST37...-0HG	5ST37...-2HG	5ST3770-0HG	5ST3770-1HG
Standards		UL 508, CSA C22.2 No. 14-M 95 / IEC 60999			
Approvals		UL 508 File No. E328403 CSA			
Operational voltage					
• Acc. to IEC	V AC	690			
• Acc. to UL 508	V AC	600			
Rated conditional short-circuit current	kA	10			
Dielectric strength	kV/mm	25			
Impulse withstand voltage	kV	> 9.5			
Max. current					
• UL	A	--	--	115	
• IEC	A	--	--	160	
Maximum busbar current IS/phase					
• Infeed at the start of the busbar	A	80	100	--	--
• Infeed at the center of the busbar	A	160	200	--	--
Insulation coordination					
• Overvoltage category		III			
• Pollution degree		2			
Short-circuit current load capability		10000 A RMS sym. 600 V for three circuits			
• 18 mm ²		100000 A RMS sym. for protection with Class J 175 A			
• 25 mm ²		100000 A RMS sym. for protection with Class J 200 A			
Busbar cross-section	mm ² Cu	18	25	--	--
Infeed		Any			
Conductor cross-sections					
• Solid	AWG	--	--	10 ... 1/0	10 ... 1
	mm ²	--	--	6 ... 35 (Cu 60 °C)	6 ... 50 (Cu 75 °C)
• Stranded	AWG	--	--	10 ... 2	
	mm ²	--	--	6 ... 35	
Terminals ± screw (Pozidriv)		--	--	2	2
Terminal tightening torque	Nm	--	--	5	3.5
	lb/in	--	--	50	35

Infeed at the start or end of the busbar

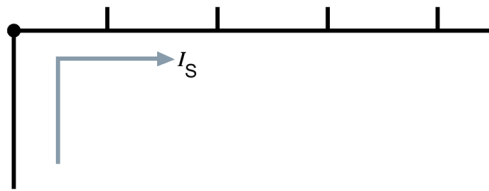

Infeed along the busbar or midpoint infeed

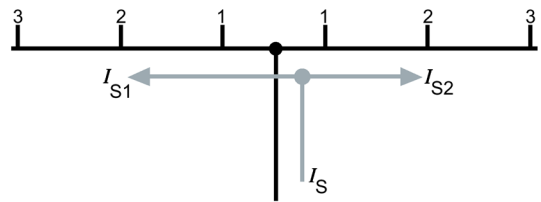

The sum of the outgoing current per branch (1, 2, 3 ... n) must not be greater than the max. busbar current I_S /phase.

8.3.3 Dimensional drawing

5ST36 touch protection covers

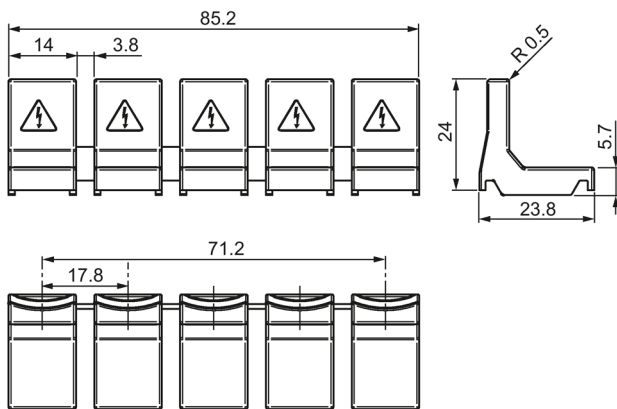

Figure 8-1 5ST3655-0HG

8.4 Busbars - 5ST2 distribution blocks

8.4.1 Overview

Distribution blocks for DIN-rail mounting

Distribution blocks can be used to implement one, two, three and four-phase systems with a rated current of up to 400 A. This allows supply terminals to be divided into several load circuits with different cable cross-sections.

The distribution blocks are made of thermoplastic with electrical and mechanical components, which enables their use under high thermal and mechanical load acc. to IEC 60947-7-1.

8.4.2 Technical specifications

		Unit	Distribution block			
			5ST2501	5ST2502	5ST2503	
Standard			IEC 60947-7-1			
Degree of protection			IP20			
Poles			4			
Approved cable			Copper			
Conductor cross-section						
<i>Inputs per pole</i>						
• Solid/stranded conductor acc. to IEC		mm ²	1 x 2.5 ... 16	1 x 6 ... 35	1 x 10 ... 35	
	Neutral conductor	mm ²	--	1 x 6 ... 35	--	
• Finely stranded with end sleeve		mm ²	1 x 2.5 ... 10	1 x 6 ... 25	1 x 10 ... 25	
	Neutral conductor	mm ²	--	1 x 6 ... 25	--	
<i>Outputs per pole</i>						
• Solid/stranded conductor acc. to IEC		Large	mm ²	8 x 1.5 ... 10	2 x 4 ... 16	3 x 6 ... 25
		Small	mm ²	--	5 x 1.5 ... 6	8 x 2.5 ... 16
	Neutral conductor	Large	mm ²	--	6 x 4 ... 16	--
		Small	mm ²	--	4 x 1.5 ... 10	--
• Finely stranded with end sleeve		Large	mm ²	8 x 1.5 ... 10	2 x 4 ... 10	3 x 6 ... 16
		Small	mm ²	--	5 x 1.5 ... 6	8 x 2.5 ... 10
	Neutral conductor	Large	mm ²	--	6 x 4 ... 10	--
		Small	mm ²	--	4 x 1.5 ... 6	--
Tightening torque						
• Input			lb/in	13.5	13.5	3.5 ... 5
			Nm	1.5	1.5	2
	Plug-in connection			PZ2	PZ2	PZ2
• Output		Large	lb/in	13.5	13.5	13.5
			Nm	1.5	1.5	1.5
	Plug-in connection			PZ1	PZ2	PZ2
	Small	lb/in	--	7.2	13.5	13.5
		Nm	--	0.8	1.5	1.5
	Plug-in connection			--	PZ1	PZ2
Operational voltage						
• IEC, max.		V	690	690	1000 V AC 1500 V DC	
Overcurrent protection						
• Max. rated current		A	80	125	175	
• Rated peak withstand current (I _{pk})		kA	21.6	24	20	
• Rated short-time withstand current I _{cw} (1 s)		kA	3	4.2	6.2	

Block dimensions (D x H x W)	Unit	Distribution block		
		mm	88 x 49 x 85	75 x 45 x 98

	Unit	UL types				
		5ST2504	5ST2505	5ST2507	5ST2508	5ST2511
Standard		UL 1059 / UL 486E / IEC 60947-7-1 UL File No. E80027 / XCFR2 C22.2 No. 158 -1987 / XCFR8			UL 1059 / UL 486E / IEC 60947-7-1 UL File No. E80027 / XCFR2	
Degree of protection		IP20				
Poles		1				
Approved cable		Copper				
Wiring type		Factory and field wiring				
• Front/back		Pressure wire connector				
Conductor cross-section						
<i>Input - large</i>						
• Solid and stranded conductor acc. to UL	AWG	3 x 14 ... 4	1 x 8 ... 2	1 x 8 ... 2 / 0	1 x 2 ... 4 / 0	1 x 3 / 0 ... 350 MCM
• Solid and stranded acc. to IEC	mm ²	3 x 2.5 ... 25	10 ... 35	10 ... 70	35 ... 120	95 ... 185
• Finely stranded with end sleeve acc. to UL	AWG	3 x 14 ... 6	1 x 8 ... 2	1 x 8 ... 1	1 x 2 ... 3 / 0	3 / 0 ... 300 MCM
• Finely stranded with end sleeve acc. to IEC	mm ²	3 x 2.5 ... 16	10 ... 35	10 ... 50	35 ... 95	95 ... 150
<i>Input - small</i>						
• Solid and stranded conductor acc. to UL	AWG	--	1 x 14 ... 6	--		
• Solid and stranded acc. to IEC	mm ²	--	2.5 ... 25	--		
• Finely stranded with end sleeve acc. to UL	AWG	--	1 x 14 ... 6	--		
• Finely stranded with end sleeve acc. to IEC	mm ²	--	2.5 ... 25	--		
<i>Output - top</i>						
• Solid and stranded conductor acc. to UL	AWG	4 x 14 ... 10	6 x 14 ... 6	6 x 14 ... 4	4 x 16 ... 8	2 x 14 ... 2
• Solid and stranded acc. to IEC	mm ²	2.5 ... 6	2.5 ... 16	2.5 ... 16	1.5 ... 10	2 x 2.5 ... 35
• Finely stranded with end sleeve acc. to UL	AWG	4 x 14 ... 10	6 x 14 ... 6	6 x 14 ... 6	2 x 14 ... 4	
• Finely stranded with end sleeve acc. to IEC	mm ²	2.5 ... 6	2.5 ... 16	2.5 ... 16	2 x 2.5 ... 25	

8.4 Busbars - 5ST2 distribution blocks

	Unit	UL types				
Output - center						
• Solid and stranded conductor acc. to UL	AWG	--			5 x 14 ... 6	
• Solid and stranded acc. to IEC	mm ²	--			2.5 ... 16	5 x 2.5 ... 16
Output - bottom						
• Solid and stranded conductor acc. to UL	AWG	4 x 14 ... 10	--		2 x 14 ... 2	4 x 14 ... 8
• Solid and stranded acc. to IEC	mm ²	2.5 ... 16	--		2 x 2.5 ... 35	42 x 2.5 ... 10
• Finely stranded with end sleeve acc. to UL	AWG	2 x 14 ... 10	--		2 x 14 ... 4	5 x 14 ... 4
• Finely stranded with end sleeve acc. to IEC	mm ²	2.5 ... 16	--		2 x 2.5 ... 25	4 x 2.5 ... 4
Tightening torque						
• Input	lb/in	13.2 ... 26.5	31 ... 44	44 ... 53	170 ... 186	222
	Nm	1.5 ... 3	3.5 ... 5	5 ... 6	19 ... 21	25
	Plug-in connection		Allen key (4 mm)	Allen key (5 mm)	Allen key (6 mm)	Allen key (8 mm)
• Output - large	lb/in	13.2 ... 26.5	17.7 ... 26.5	13.2 ... 26.5	31 ... 62	
	Nm	1.5 ... 3	2 ... 3	1.5 ... 3	3.5 ... 7	
	Plug-in connection	PZ2			Standard screwdriver	
• Output - small	lb/in	7 ... 13.2	--		18 ... 27	
	Nm	0.8 ... 1.5	--		2 ... 3	
	Plug-in connection	PZ1	--		Standard screwdriver	
Amperes per pole, max. (UL/IEC)	A	80 / 80	115 / 125	160 / 160	230 / 250	310 / 400
Operational voltage						
• UL, max. (AC)	V	600				
• IEC, max. (AC/DC)	V	1000 / 1500				
Overcurrent protection						
• Required class		J				
• Max. rated current (UL/IEC)	A	80 / 80	115 / 125	160 / 160	230 / 250	310 / 400
• SCCR RMS Sym A	kA	100				
• Rated peak withstand current (I _{pk})	kA	2.7	30		51	

	Unit	UL types				
<ul style="list-style-type: none"> Rated short-time withstand current (I_{cw} 1 s) 	kA	1.9	4.2	11	21	
Clearance						
<ul style="list-style-type: none"> Air 	in (mm)	3 / 8 (9.5)				
<ul style="list-style-type: none"> Creepage distance 	in (mm)	1 / 2 (12.7)				
Ambient temperature	°C	-25 ... +75				
Fire class		UL 94V-0				
Block dimensions (D x H x W)	mm	66 x 47 x 27	74 x 47 x 27	92 x 49 x 35	96 x 49 x 45	96 x 49 x 45
Connections		With cable up to 16 mm ²	With connector or cable up to 16 mm ² ¹⁾	Lateral incoming feeder for parallel connection with copper bar (max. 16 x 5 mm)	--	--

¹⁾ Copper jumper is tested for a rated current of 100 A

8.4.3 Dimensional drawings

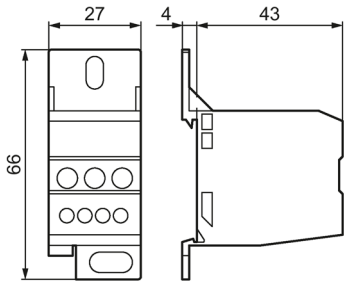

5ST2504

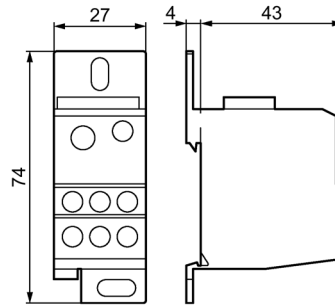

5ST2505

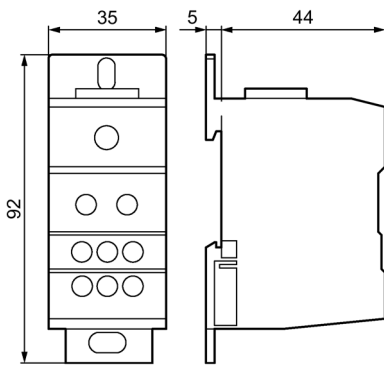

5ST2507

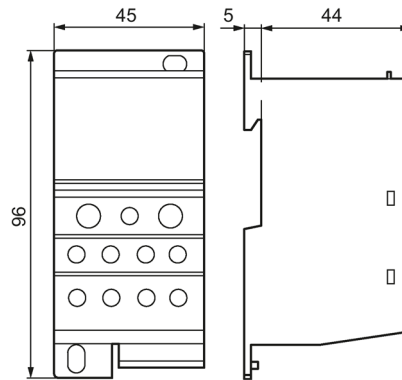

5ST2508

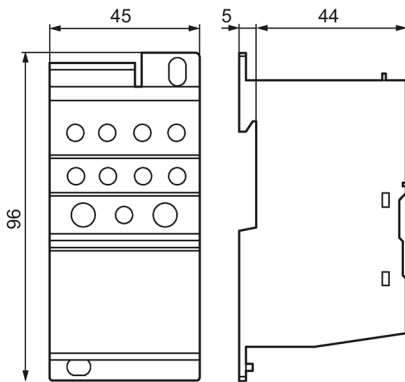

5ST2511

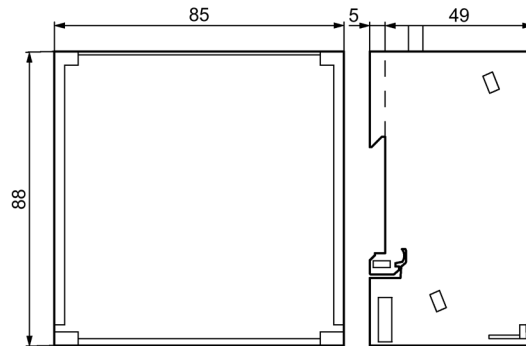

5ST2501

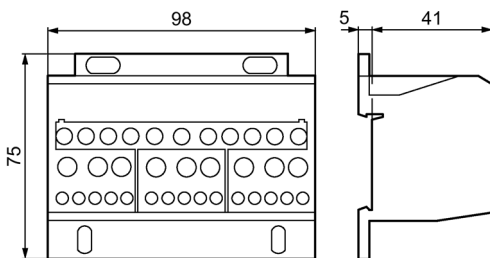

5ST2502

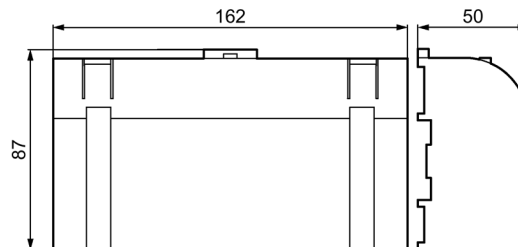

5ST2503

8.5 SIKclip wiring system

8.5.1 Overview

SIKclip is a fast wiring system that simplifies the connection of flush-mounting circuit breakers:

- For mounting directly on the rear vertical CU busbar system
- Mounting via brackets on the rear of the DIN rail

The 4-pole busbar can handle loads of up to 250 A, each individual contact up to 63 A.

High degree of protection because each contact is locked individually.

SIKclip is made of thermoplastic acc. to IEC 60439-3 and is suitable for high thermal loads.

Note

To install the SIKclip wiring system in the ALPHA AS, the busbars must be installed in a vertical rear position, but not recessed. If the busbars are in a recessed position the cables will not reach the circuit breakers.

8.5.2 Technical specifications

	Unit	Circuit breaker
		5ST25..
Standards		UL 1059 / UL 486E / IEC 60947-7-1 UL File No. E80027 / XCFR2
Degree of protection		IP20
Max. rated current I_n	A	250 at 40 °C ambient temperature
Max. rated output current I_n	A	63 at 40 °C ambient temperature
Rated operational voltage U_n	V AC	400
Rated insulation voltage	V AC	660
Test voltage	kV	2.5, 50 Hz
Connecting cables		40 A (6 mm ²), 63 A (10 mm ²)
Connecting cable type		H07VK
Ambient temperature	°C	-5 ... +60

8.5.3 Dimensional drawings

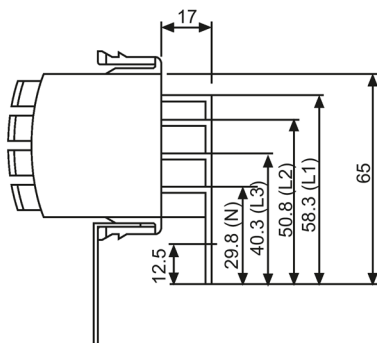
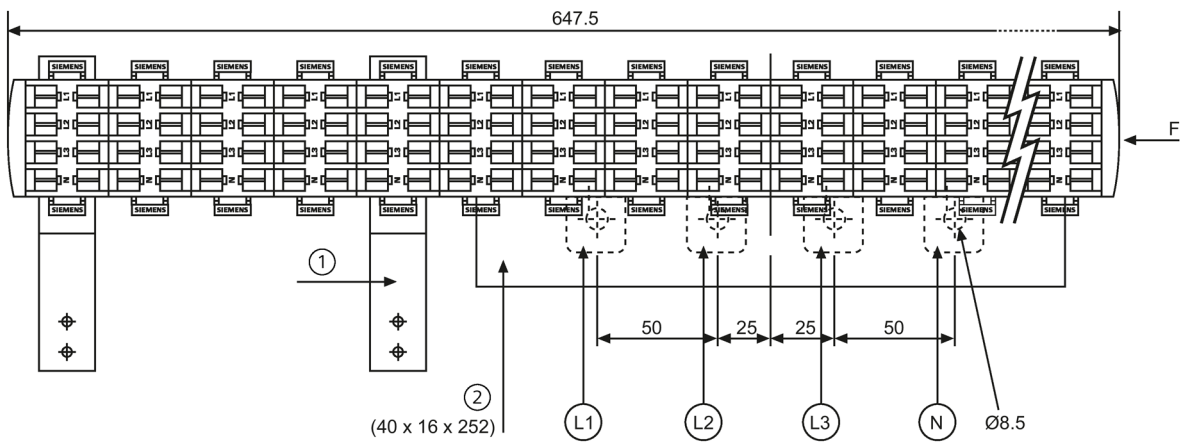
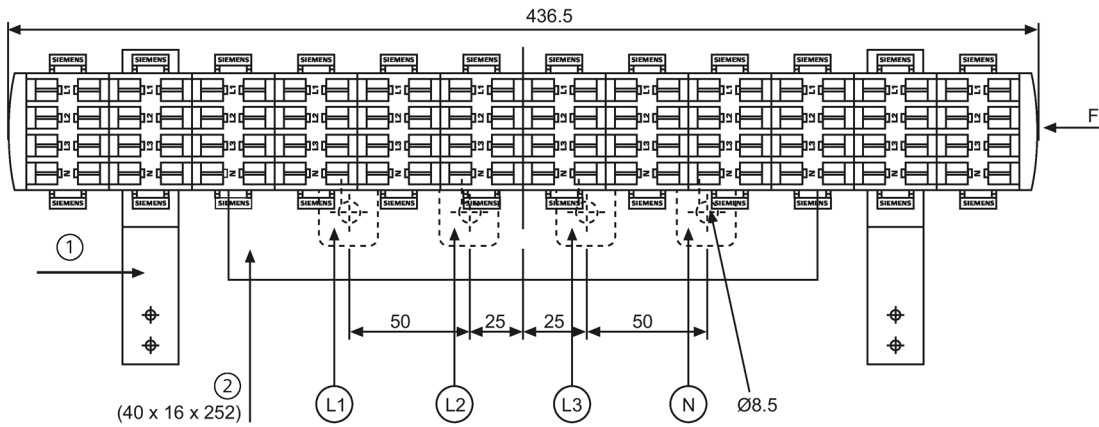

- ① Mounting bracket
- ② Transparent protective cover

Configuration and dimensioning

9.1 Switching capacity

Overview

Particular demands are made on miniature circuit breakers with regard to switching capacity.

The values are standardized and are determined according to the test conditions of IEC/EN 60898-1/-2 or DIN VDE 0641-11.

The values of the rated switching capacity I_{cn} are **6000** , **10000** and **15000** .

For other test conditions, it is also possible to specify values higher than those stipulated in IEC/EN 60898-1/-2 or DIN VDE 0641-11.

One such standard is IEC/EN 60947-2 or DIN VDE 0660-101 for circuit breakers.

5SL3, 5SL4, 5SL6, 5SY6, 5SY4, 5SY7, 5SY8 and 5SP miniature circuit breakers

		IEC/EN 60898-1		IEC/EN 60947-2	
		1-pole, 1-pole+N	2-, 3-, 4-pole, 3-pole+N	1-pole, 1-pole+N	2-, 3-, 4-pole, 3-pole+N
		230 V AC	400 V AC	230 V AC	400 V AC
	I_n [A]	I_{cn} [kA]	I_{cn} [kA]	I_{cu} [kA]	I_{cu} [kA]
5SL3 (without 5SL30)	0.3 ... 63	4.5		--	
5SL4	0.3 ... 63	10		10	
5SL6 (without 5SL60)	0.3 ... 63	6		6	
5SY6 (without 5SY60)	0.3 ... 6	6		30	
	8 ... 32	6		15	
	40 ... 63	6		10	
5SY4	0.3 ... 6	10		35	
	8 ... 32	10		20	
	40 ... 63	10		15	
	80	10		10	
5SY7	0.3 ... 2	15		50	
	3 ... 6	15		40	
	8 ... 10	15		30	
	13 ... 32	15		25	
	40 ... 63	15		20 ¹⁾	
5SY8	0.3 ... 2	--		70	
	3 ... 6	--		50	
	8 ... 10	--		40	
	13 ... 32	--		30	
	40 ... 63	--		25 ²⁾	
5SL30	2 ... 40	4.5	--	--	--
5SL60	2 ... 40	6	--	6	--
5SP4	80 ... 125	10		10	

¹⁾ D50 and D63: I_{cu} = 15 kA.

²⁾ D50 and D63: I_{cu} = 20 kA.

5SY5 and 5SP5 miniature circuit breakers

Miniature circuit breakers, universal current		IEC/EN 60898-2		IEC/EN 60898-2	
		1-pole	2-pole	1-pole	2-pole
		230/400 V AC	400 V AC	220 V DC	440 V DC
	I_n [A]	I_{cn} [kA]	I_{cn} [kA]	I_{cn} [kA]	I_{cn} [kA]
5SY5	0.3 ... 63	10		10	
5SP5	80 ... 125	--		10	

5SL30 and 5SL60 miniature circuit breakers

Rated making and breaking capacity I_{cn1}		IEC/EN 60898-1	
		1-pole + N	
		230 V AC	
	I_n [A]	I_{cn1} [kA]	
5SL30	2 ... 16	4.5	
	20 ... 40	3	
5SL60	2 ... 4	6	
	6 ... 16	4.5	
	20 ... 40	3	

9.2 Characteristic curves

9.2.1 Tripping characteristics acc. to IEC / EN 60898-1, DIN VDE 0641-11

The tripping characteristic applies to a frequency of 50 Hz to 60 Hz. Correction factors must be taken into account for other frequencies or if direct current is used, see Correction factors for rated current at different frequencies (Page 97)

Tripping characteristic A

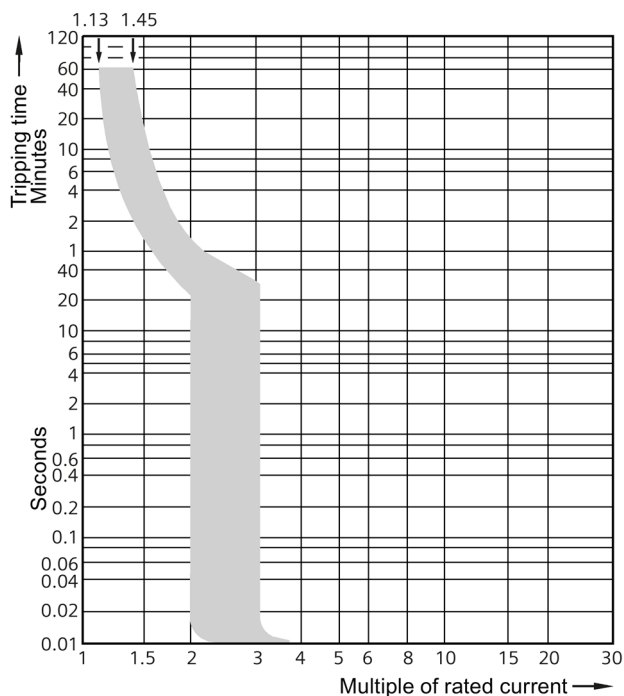

For limited semiconductor protection, protection of measuring circuits with transformers.

Tripping characteristic B

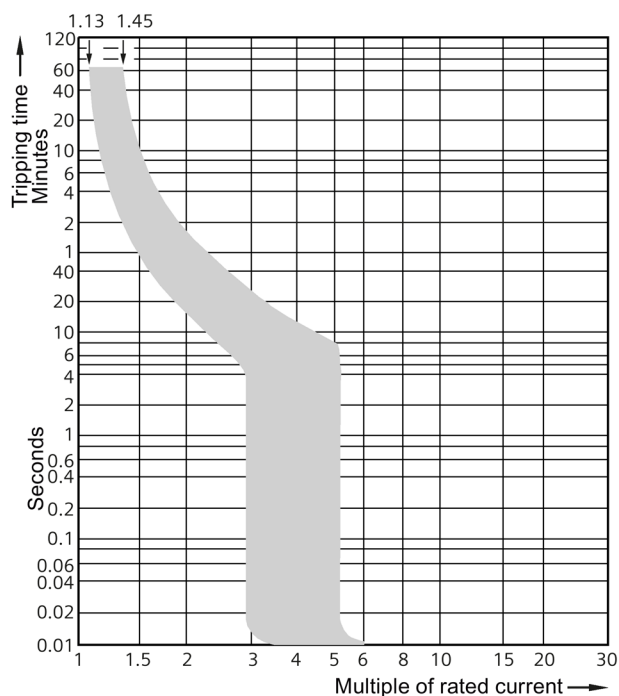

MCBs with this tripping characteristic are designed for use in socket outlet and lighting circuits, for example.

Tripping characteristic C

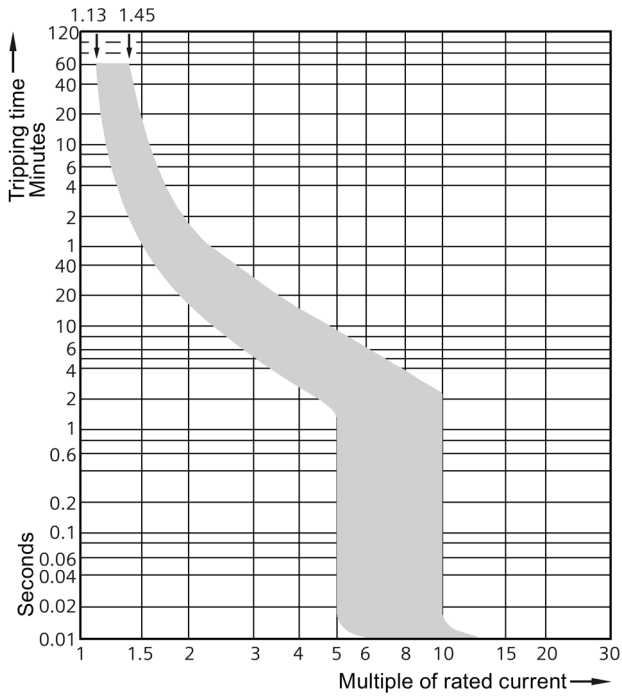

In lamp and motor circuits with higher starting currents, MCBs with tripping characteristic C are preferred.

Tripping characteristic D

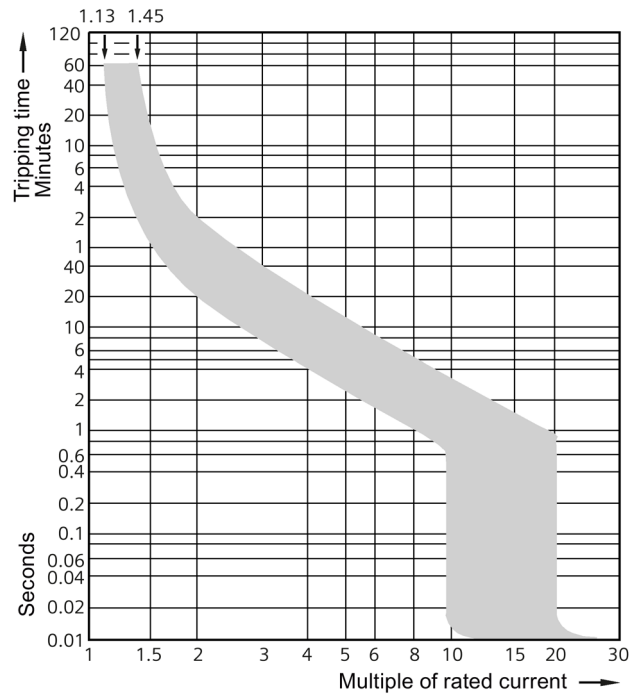

For electrical circuits with strong pulse-generating equipment, such as transformers or solenoid valves.

9.2.2 Tripping characteristics at different ambient temperatures

9.2.2.1 Tripping behavior at 30 °C ambient temperature

Tripping characteristic	Standards	Thermal release				Electromagnetic release		
		Test currents:				Test currents:		
		Low test current	High test current	Tripping time $I_n \leq 63 \text{ A}$	$I_n > 63 \text{ A}$	Hold	Latest tripping	Tripping time
I_1	I_2	t	t	I_4	I_5	t		
A	--	$1.13 \times I_n$	$1.45 \times I_n$	$> 1 \text{ h}$ $< 1 \text{ h}$	$> 2 \text{ h}$ $< 2 \text{ h}$	$2 \times I_n$	$3 \times I_n$	$\geq 0.1 \text{ s}$ $< 0.1 \text{ s}$
B	IEC/EN 60898-1, DIN VDE 0641-11	$1.13 \times I_n$	$1.45 \times I_n$	$> 1 \text{ h}$ $< 1 \text{ h}$	$> 2 \text{ h}$ $< 2 \text{ h}$	$3 \times I_n$	$5 \times I_n$	$\geq 0.1 \text{ s}$ $< 0.1 \text{ s}$
C	IEC/EN 60898-1, DIN VDE 0641-11	$1.13 \times I_n$	$1.45 \times I_n$	$> 1 \text{ h}$ $< 1 \text{ h}$	$> 2 \text{ h}$ $< 2 \text{ h}$	$5 \times I_n$	$10 \times I_n$	$\geq 0.1 \text{ s}$ $< 0.1 \text{ s}$
D	IEC/EN 60898-1, DIN VDE 0641-11	$1.13 \times I_n$	$1.45 \times I_n$	$> 1 \text{ h}$ $< 1 \text{ h}$	$> 2 \text{ h}$ $< 2 \text{ h}$	$10 \times I_n$	$20 \times I_n$ (IEC 60898: $50 \times I_n$)	$\geq 0.1 \text{ s}$ $< 0.1 \text{ s}$

9.2.2.2 Correction factors for the rated current at different ambient temperatures for 5SL3...- and 5SL6...- (without 5SL30 and 5SL60)

Dependence of the permissible continuous load current on the ambient temperature for 5SL3...- and 5SL6...- miniature circuit breakers (without 5SL30 and 5SL60)

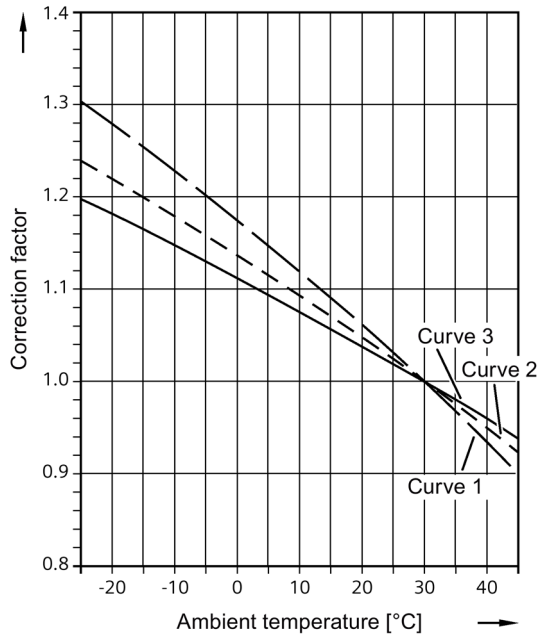

The valid curve for the correction factor can be found in the following table.

Valid curve for the correction factor for 5SL3...- and 5SL6...- miniature circuit breakers (without 5SL30 and 5SL60)		0.3	0.5	1	1.6	2 ¹⁾	3	4 ¹⁾	6	8	10	13	16	20	25	32	40	50	63
B	1P					2		2	1		2	2	2	2	1	1	3	1	1
	2P/1+N								1		2	2	3	2	1	2	2	1	2
	3P/4P								2		2	2	3	2	2	3	2	2	2
	4P/3+N								2		2	2	3	3	2	3	2	2	3
C	1P	1	2	2	2	2	2	1	1	2	1	2	3	2	1	1	2	1	1
	2P/1+N	1	2	2	3	3	2	2	1	2	1	2	3	3	1	2	2	1	2
	3P/4P	1	2	2	3	3	3	2	1	2	1	2	3	2	2	2	2	2	2
	4P/3+N	1	2	2	3	3	3	2	2	2	1	2	3	3	2	3	2	2	2

¹⁾ Only available as 5SL6

9.2.2.3 Correction factors for the rated current at different ambient temperatures for 5SL30 and 5SL60..-.

Dependence of the permissible continuous load current on the ambient temperature for 5SL30 and 5SL60..- miniature circuit breakers

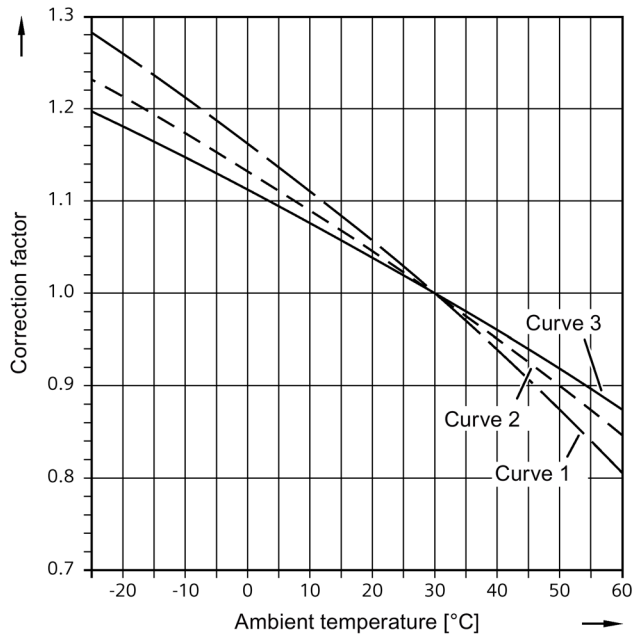

The valid curve for the correction factor can be found in the following table.

Valid curve for the correction factor for 5SL30..- and 5SL60..- miniature circuit breakers												
Rated current (A)		2	4	6	8	10	13	16	20	25	32	40
B	$1+N/N+1$			3		2	2	2	2	3	2	2
C	$1+N/N+1$	3	3	3	1	2	2	1	1	3	2	2

9.2.2.4 Correction factors for the rated current at different ambient temperatures for 5SL4...-

Dependence of the permissible continuous load current on the ambient temperature for 5SL4...- miniature circuit breakers

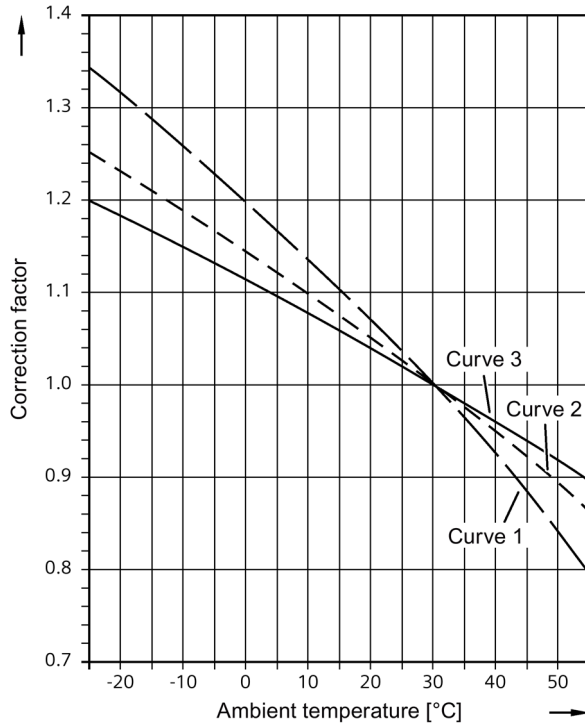

The valid curve for the correction factor can be found in the following table.

Valid curve for the correction factor for 5SL4...- miniature circuit breakers																			
Rated current (A)		0.3	0.5	1	1.6	2	3	4	6	8	10	13	16	20	25	32	40	50	63
B	1P			3		3	2	2	2	1	1	1	1	1	1	1	1	1	1
	2P/1+N			3		3	2	3	3	1	1	1	1	1	1	1	2	1	2
	3P/4P/ 3+N			3		3	3	3	3	1	1	2	2	2	2	2	2	2	2
C	1P	1	2	2	3	3	2	2	2	1	1	1	1	1	2	1	1	1	1
	2P/1+N	2	2	2	3	3	2	2	2	1	1	1	1	2	2	1	1	1	2
	3P	2	2	2	3	3	3	3	3	1	1	2	2	2	2	1	2	2	2
	4P/3+N	2	2	2	3	3	3	3	3	1	1	2	2	2	2	2	2	2	2
D	1P	1	2	3	3	3	2	2	2	1	1	1	1	1	1	1	1	1	1
	2P/1+N	2	2	3	3	3	2	2	2	1	1	1	1	1	1	1	2	1	2
	3P/4P/ 3+N	2	2	3	3	3	3	3	3	1	1	1	1	1	2	2	2	2	2

9.2.2.5 Correction factors for the rated current at different ambient temperatures for 5SY

Dependence of the permissible continuous load current on the ambient temperature for 5SY6 and 5SY8 miniature circuit breakers

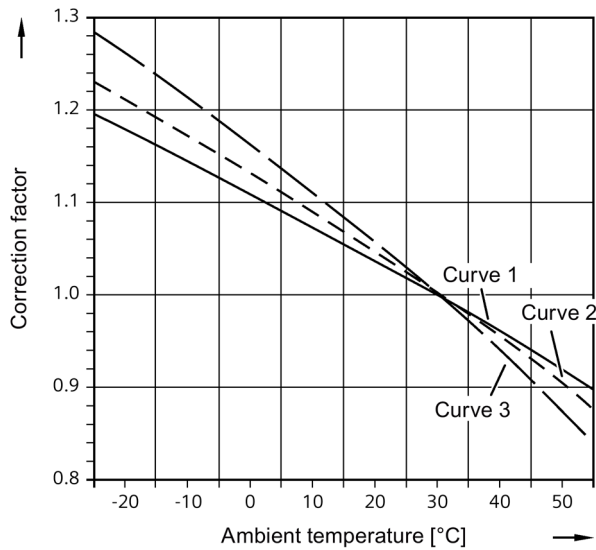

The valid curve for the correction factor can be found in the following table.

Valid curve for the correction factor for 5SY6 and 5SY8 miniature circuit breakers																			
Rated current (A)		0.3	0.5	1	1.6	2	3	4	6	8	10	13	16	20	25	32	40	50	63
B	1P/2P					2		3	3		3	2	2	3	3	2	3	2	3
	3P/4P								2		2	1	2	2	1	1	1	1	2
C	1P/2P	3	3	2	2	2	3	3	3	3	3	2	3	3	2	2	3	2	3
	3P/4P	2	2	2	1	2	2	2	2	3	3	2	2	2	2	1	1	1	2
D	1P/2P	3	3	2	2	2	3	3	3	3	3	2	3	3	2	2	3	2	3
	3P/4P	2	2	2	1	2	2	2	2	3	3	2	2	2	2	2	2	1	2

Dependence of the permissible continuous load current on the ambient temperature for 5SY4, 5SY5 and 5SY7 miniature circuit breakers

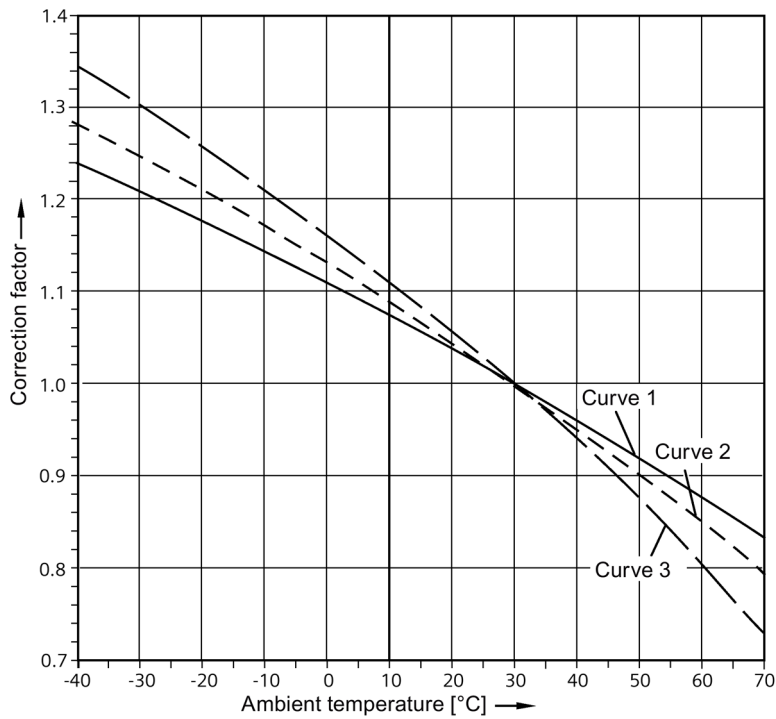

9.2 Characteristic curves

The valid curve for the correction factor can be found in the following table.

Valid curve for the correction factor for 5SY4, 5SY5 and 5SY7 miniature circuit breakers																					
Rated current (A)		0.3	0.5	1	1.6	2/ 2.5	3/ 3.5	4/5	6	8	10	13/ 15	16	20	25/ 30	32/ 35	40/ 45	50	60/ 63	80	
A	1P/2P		3	2	2	2	3	3	3	2	3	2	2	3	2	2	3	2	3		
	3P/4P		2	2	1	2	2	2	2	2	2	1	1	2	1	1	1	1	2		
B	1P/2P				2	2	2	3	3	3	2	3	2	2	3	3	2	3	2	3	2
	3P/4P				2	1	2	2	2	2	2	2	1	2	2	1	1	1	1	2	1
C	1P/2P	3		3	2	2	2	3	3	3	3	3	2	3	3	2	2	3	2	3	2
	3P/4P	2		2	2	1	2	2	2	2	3	3	2	2	2	2	1	1	1	2	1
D	1P/2P	3	3	2	2	2	3	3	3	3	3	2	3	3	2	2	3	2	3		
	3P/4P	2	2	2	1	2	2	2	2	3	3	2	2	2	2	2	2	1	2		

9.2.2.6 Correction factors for the rated current at different ambient temperatures for 5SP4

Dependence of the permissible continuous load current on the ambient temperature for 5SP4 miniature circuit breakers

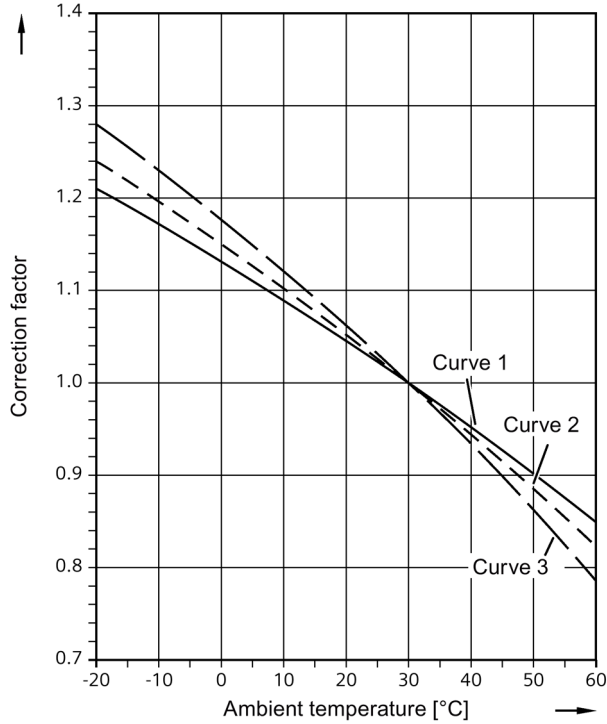

The valid curve for the correction factor can be found in the following table.

Valid curve for the correction factor for 5SP4 miniature circuit breakers				
Rated current (A)		80	100	125
A	1P	2	3	3
	2P/3P/4P	1	1	1
B	1P	2	3	3
	2P/3P/4P	1	1	1
C	1P	2	3	-
	2P/3P/4P	1	1	-

9.2.2.7 Correction factors for the rated current at different ambient temperatures for 5SP5

Dependence of the permissible continuous load current on the ambient temperature for 5SP5 miniature circuit breakers

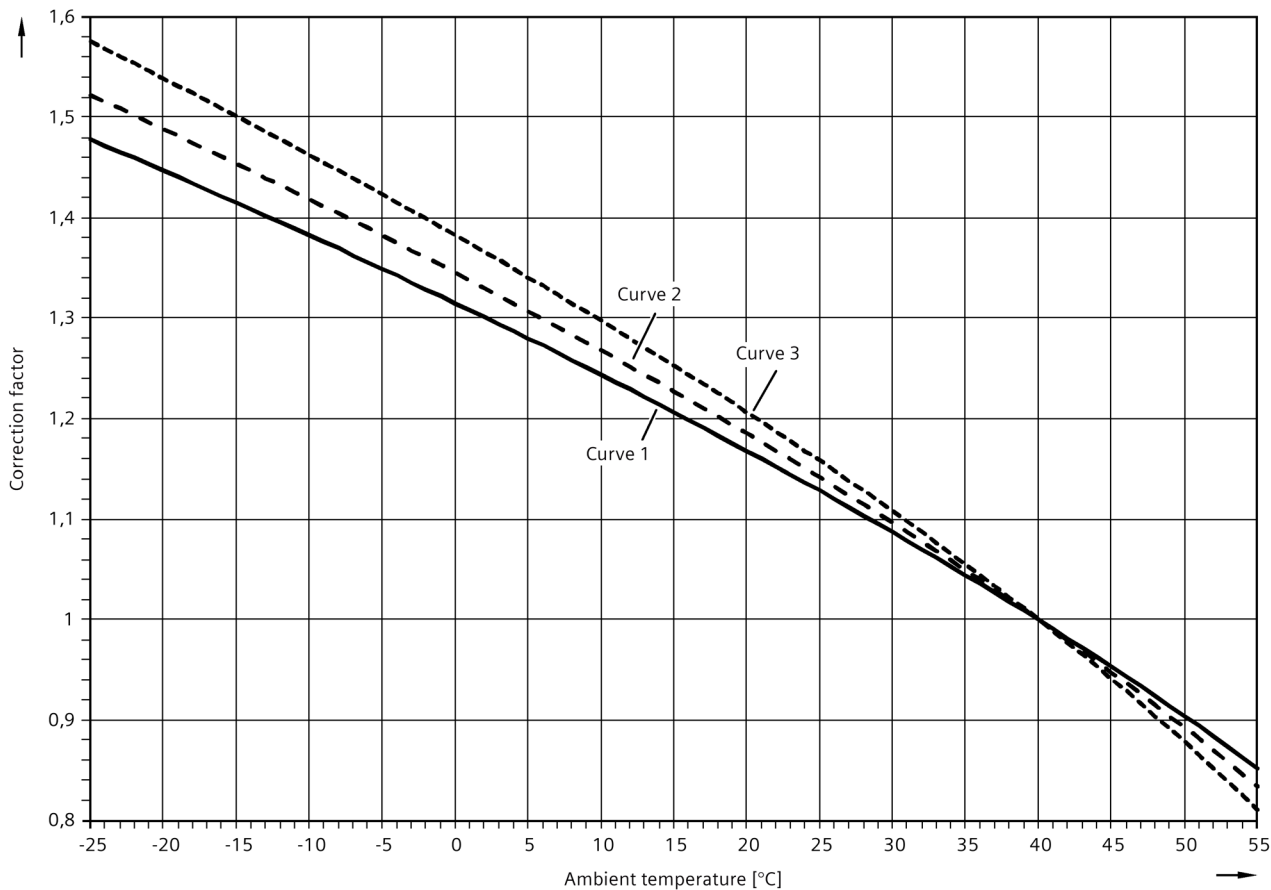

The valid curve for the correction factor can be found in the following table.

Valid curve for the correction factor for 5SP5 miniature circuit breakers				
Rated current (A)		80	100	125
C	1P	2	3	3
	2P	1	2	3

9.2.2.8 Correction factors for the rated current at different ambient temperatures for 5SL6 COM

Dependence of the permissible continuous load current on the ambient temperature for 5SL6 COM miniature circuit breakers

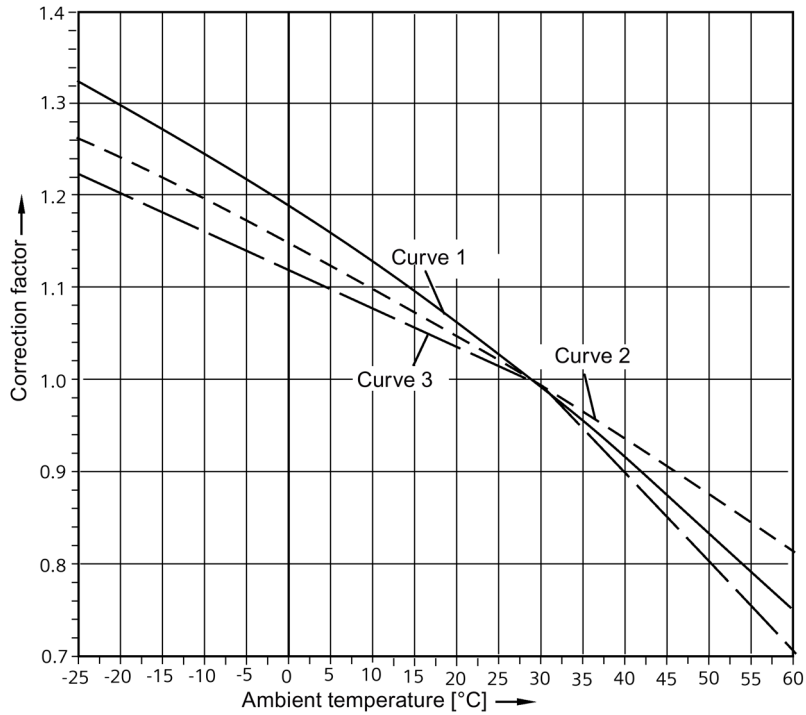

The valid curve for the correction factor can be found in the following table.

Valid curve for the correction factor for 5SL6 COM miniature circuit breakers											
Rated current (A)		2	4	6	8	10	13	16	20	25	32
B	1+N	2	2	1	-	1	1	2	2	3	3
C	1+N	2	2	1	1	1	1	2	2	3	3

9.2.3 Correction factors for rated current if bundling

If more than one electrical circuit is loaded in a series of miniature circuit breakers the resulting increase in ambient temperature affects the characteristic curve. In this case an additional correction factor, specific to the rated current of the miniature circuit breaker, must be taken into account.

Number of MCBs	1	2 ... 3	4 ... 6	> 7
Correction factor K	1.00	0.90	0.88	0.85

Correction factors for rated switching capacities I_{cn} depending on altitude above sea level

Altitude above sea level / m	Correction factor	I_{cn} / kA 5SY5	I_{cn} / kA 5SY6	I_{cn} / kA 5SY4	I_{cn} / kA 5SY7	I_{cn} / kA 5SP4
500	1	10	6	10	15	10
1000	1	10	6	10	15	10
1500	1	10	6	10	15	10
2000	1	10	6	10	15	10
2500	0.94	9.4	5.6	9.4	14.1	9.4
3000	0.88	8.8	5.3	8.8	13.2	8.8
3500	0.83	8.3	5	8.3	12.4	8.3
4000	0.78	7.8	4.7	7.8	11.7	7.8

Correction factors for rated ultimate short-circuit breaking capacity I_{cu} depending on altitude above sea level.

Altitude above sea level / m	Correction factor	I_{cu} / kA 5SY5
500	1	10
1000	1	10
1500	1	10
2000	1	10
2500	0.94	9.4
3000	0.88	8.8
3500	0.83	8.3
4000	0.78	7.8

9.2.4 Correction factors for rated current at different frequencies

The tripping characteristic applies to a frequency of 50 Hz to 60 Hz. In the case of other frequencies, the following correction factors must be taken into account.

In the overload range, the limits of the characteristic curves correspond to the correction factors of the thermal tripping operation. In the event of a short-circuit, the limits of the characteristic curves correspond to the correction factors of the magnetic tripping operation.

Thermal tripping operation

	Rated current I_n (A)	Correction factor for					
		0 Hz ¹⁾	16 2/3 Hz	50/60 Hz	125 Hz	400 Hz	1000 Hz
5SL4...-*	0.3 ... 6	1	1	1	1	1	1
	8 ... 20	1	1	1	1	0.99	0.98
	25 ... 40	1	1	1	1	0.99	0.96
	50 ... 63	1	1	1	0.99	0.96	0.92
5SY* (without 5SY.0)	0.3 ... 10	1	1	1	1	0.99	0.97
	1 ... 40	1	1	1	0.98	0.97	0.93
	50 ... 63	1	1	1	0.98	0.94	0.86
5SP4	80 ... 125	1	1	1	0.97	0.92	0.85

¹⁾ Corresponds to DC voltage

^{*)} 5SL and 5SY: Exceptions for direct current, see Technical specifications (Page 20) therm. and magn.

	Rated current I_n (A)	Correction factor for					
		0 Hz ¹⁾	16 2/3 Hz	50/60 Hz	125 Hz	400 Hz	1000 Hz
5SL3n...-	0.3 ... 4	1 ²⁾	1	1	0.99	0.97	0.97
5SL6n...- (without 5SL.0)	6 ... 10	1	1	1	0.99	0.99	0.98
	13 ... 25	1	1	1	1	0.97	0.95
	32	1	1	1	0.99	0.94	0.86
	40 ... 63	1	1	1	1	0.97	0.94

¹⁾ Corresponds to DC voltage

²⁾ Except: C0.3 ... 1 A

9.2 Characteristic curves

	Rated current I_n (A)	Correction factor for					
		0 Hz ¹⁾	16 2/3 Hz	50/60 Hz	125 Hz	400 Hz	1000 Hz
5SL30 5SL60	2 ... 4	1	1	1	0.99	0.97	0.97
	6 ... 10	1	1	1	0.99	0.99	0.98
	13 ... 25	1	1	1	1	0.97	0.95
	32	1	1	1	0.99	0.94	0.86
	40	1	1	1	1	0.97	0.94

1) Corresponds to DC voltage

	Rated current I_n (A)	Correction factor for				
		16 2/3 Hz	50/60 Hz	125 Hz	400 Hz	1000 Hz
5SL60... .MC		0.99	1	0.99	0.98	0.97

Magnetic tripping operation

	Rated current I_n (A)	Correction factor for					
		0 Hz ¹⁾	16 2/3 Hz	50/60 Hz	125 Hz	400 Hz	1000 Hz
5SL4...-	B1 ... B63	2	1.2	1	1.3	1.6	2.0
	C0.3 ... C63	1.6 ²⁾	1.2	1	1.2	1.5	1.9
	D0.3 ... D63	1.6 ²⁾	1.1	1	1.2	1.5	1.8
5SY (without 5SY.0)	0.3 ... 63	1.4	1	1	1.2	1.4	1.7
5SP4	80 ... 125	1.5	1	1	1.05	1.3	1.8

1) Corresponds to DC voltage

2) Except: C0.3...1 A, D0.3 ... 2 A

	Rated current I_n (A)	Correction factor for					
		0 Hz ¹⁾	16 2/3 Hz	50/60 Hz	125 Hz	400 Hz	1000 Hz
5SL3n...- 5SL6n...- (without 5SL.0)	0.3 ... 4	1.5 ²⁾	1.2	1	1.2	1.5	1.9
	6 ... 10	1.7	0.9	1	1.2	1.4	1.6
	13 ... 25	1.8	1.0	1	1.2	1.5	1.6
	32	2.1	1.4	1	1.4	1.6	1.8
	40 ... 63	2.0	1.1	1	1.2	1.4	1.8

1) Corresponds to DC voltage

2) Except: C0.3 ... 1 A

	Rated current I_n (A)	Correction factor for					
		0 Hz ¹⁾	16 2/3 Hz	50/60 Hz	125 Hz	400 Hz	1000 Hz
5SL30	2 ... 10	1.7	0.9	1	1.2	1.4	1.6
5SL60	13 ... 25	1.8	1	1	1.2	1.5	1.6
	32	2.1	1.4	1	1.4	1.6	1.8
	40	2	1.1	1	1.2	1.4	1.8

1) Corresponds to DC voltage

	Rated current I_n (A)	Correction factor for				
		16 2/3 Hz	50/60 Hz	125 Hz	400 Hz	1000 Hz
5SL60..- .MC		0.94	1	1.14	1.33	1.44

9.2.5 Consideration of minimum clearances

In the event of short-circuit trips, miniature circuit breakers discharge ionized gases. These gases can result in electrical arcing at device terminals from devices or other live parts mounted above or below them. To avoid such arcing, a minimum clearance (known as the grid distance; see IEC/EN 60898-1) must be maintained above and below the miniature circuit breakers for mounting on DIN rails.

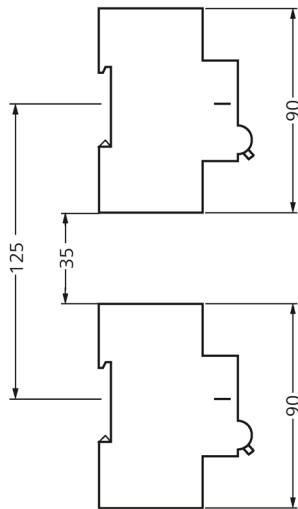

Example 1: With a minimum clearance of 35 mm (e.g. 5SL, 5SY) and a miniature circuit breaker frame size of 90 mm, the minimum DIN rail clearance is 125 mm.

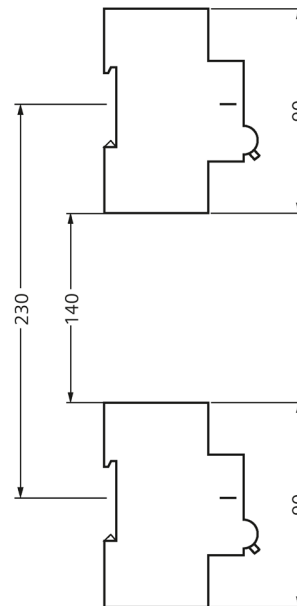

Example 2: With a minimum clearance of 140 mm (e.g. 5SP4) and a miniature circuit breaker frame size of 90 mm, the minimum DIN rail clearance is 230 mm.

Characteristic curves for let-through I^2t values

5SL3 (AC) (without 5SL30)

Characteristic B

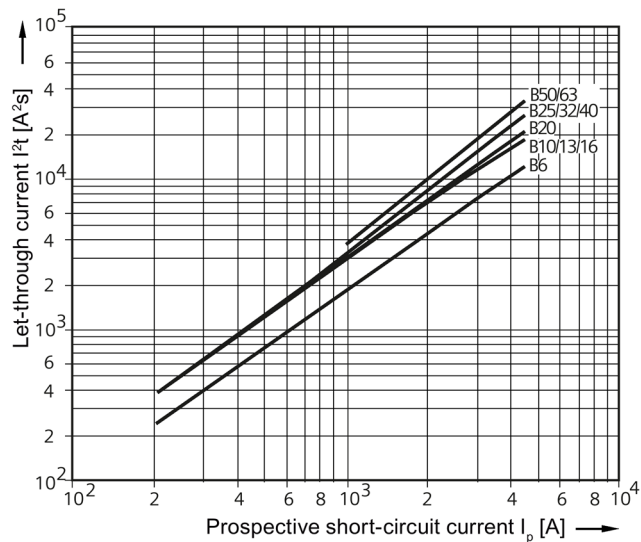

Characteristic C

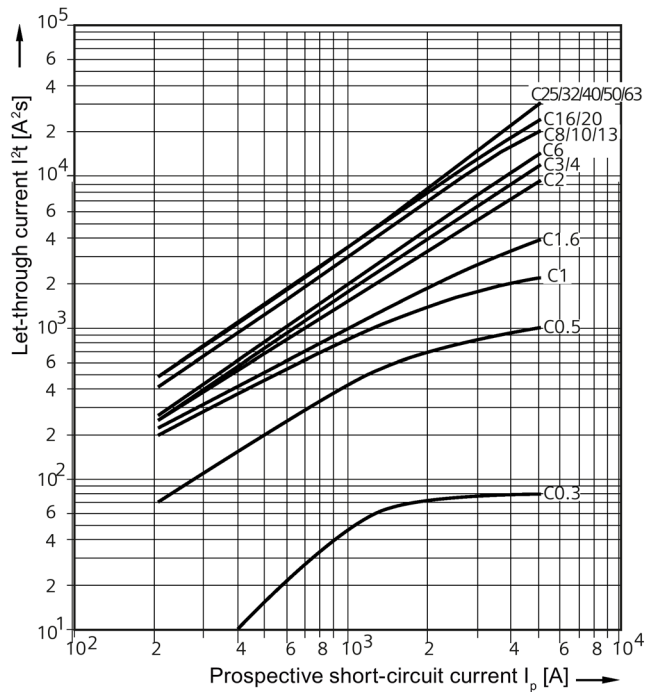

Characteristic curves for let-through I^2t values

5SL4...-6 (AC)

Characteristic B

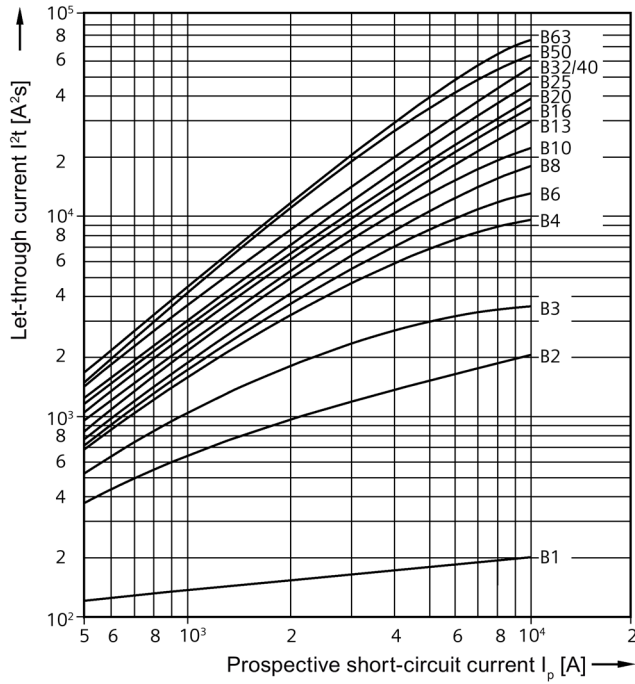

5SL4...-7 (AC)

Characteristic C

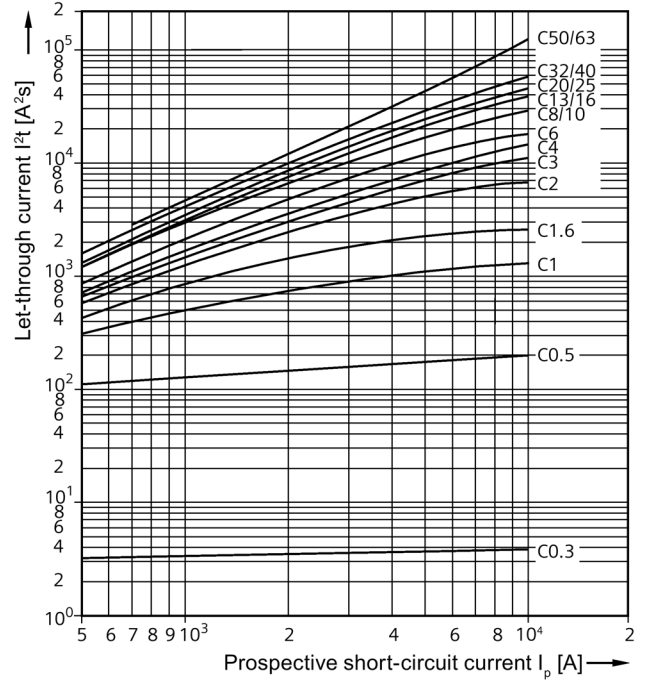

5SL4...-8 (AC)

Characteristic D

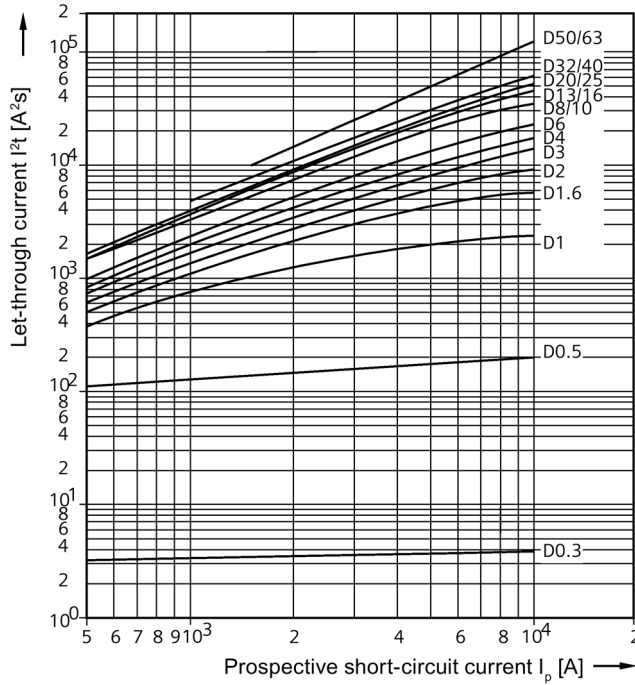

Characteristic curves for let-through I^2t values

5SL6 (AC) (without 5SL60)

Characteristic B

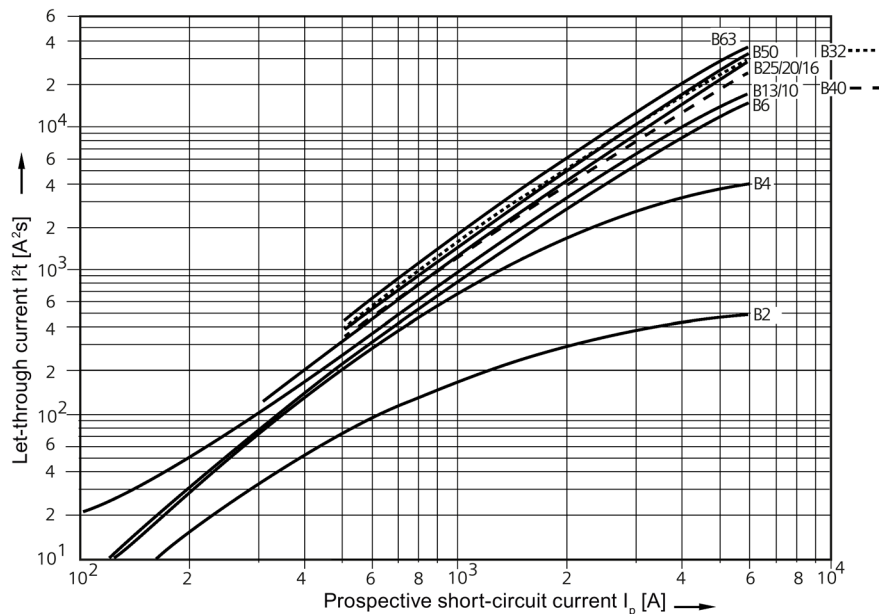

Characteristic C

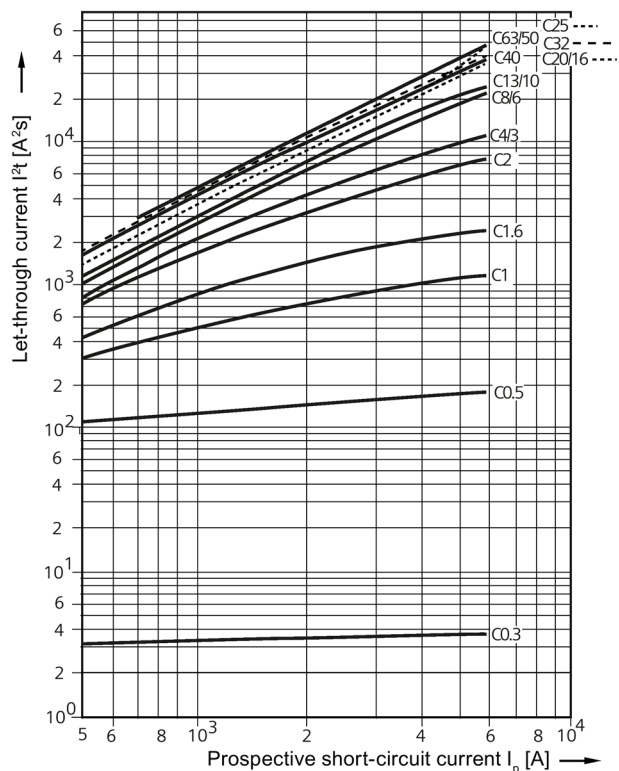

Characteristic curves for let-through I^2t values

5SY4 (AC)

Characteristic A

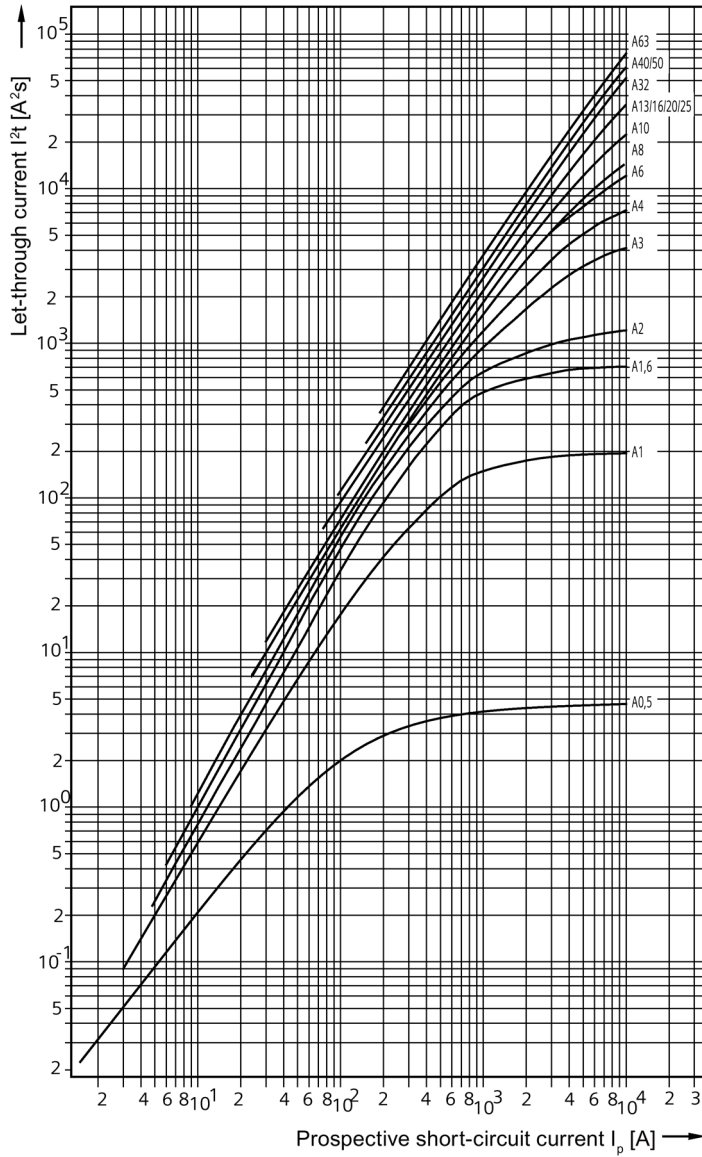

Characteristic B

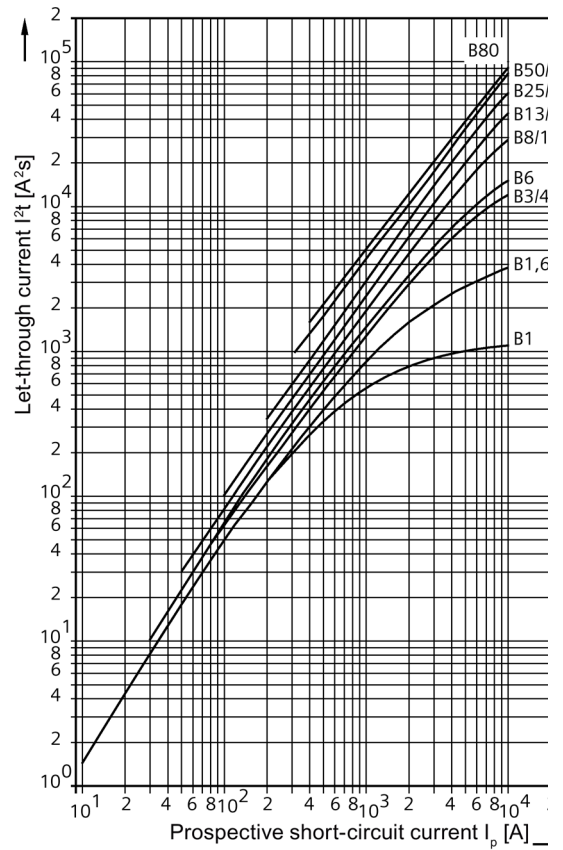

Characteristic C

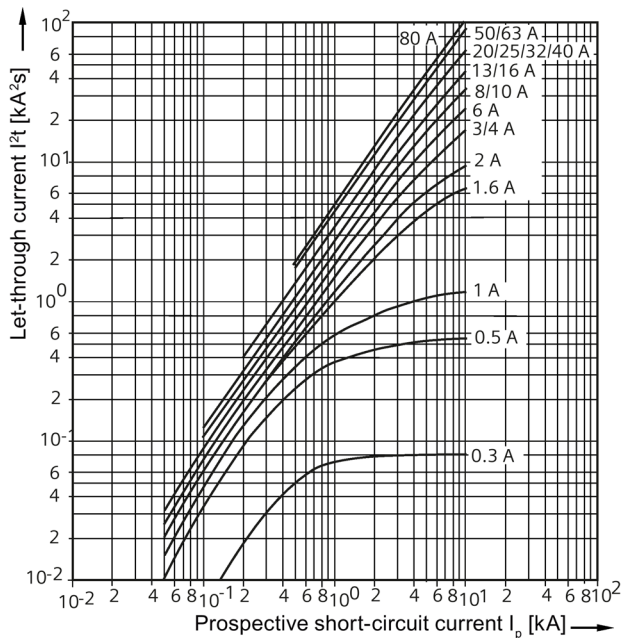

Characteristic D

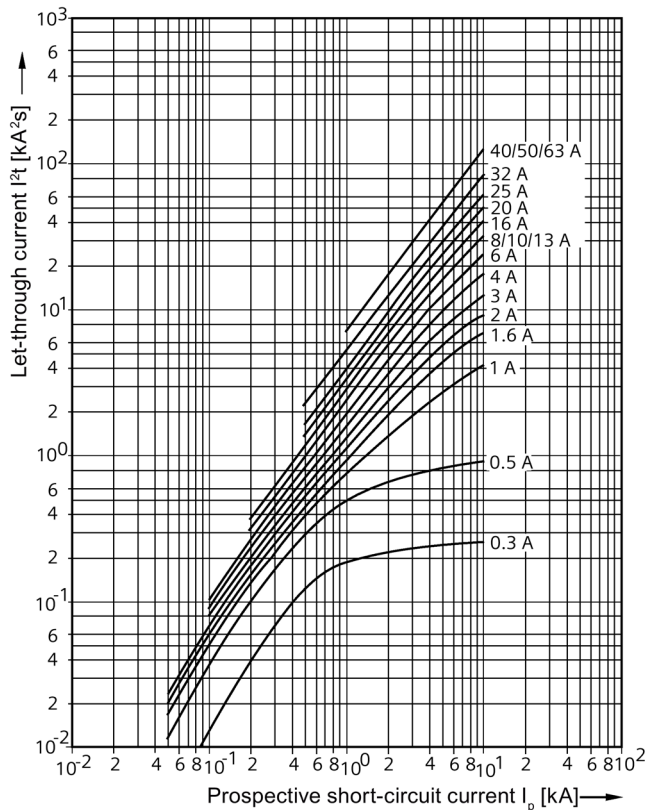

Characteristic curves for let-through I^2t values

5SY5 (AC)

Characteristic B

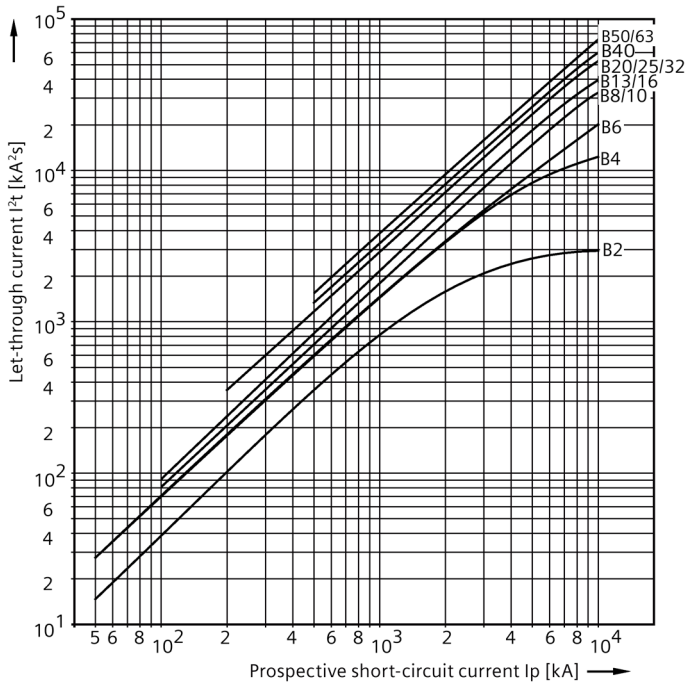

Characteristic C

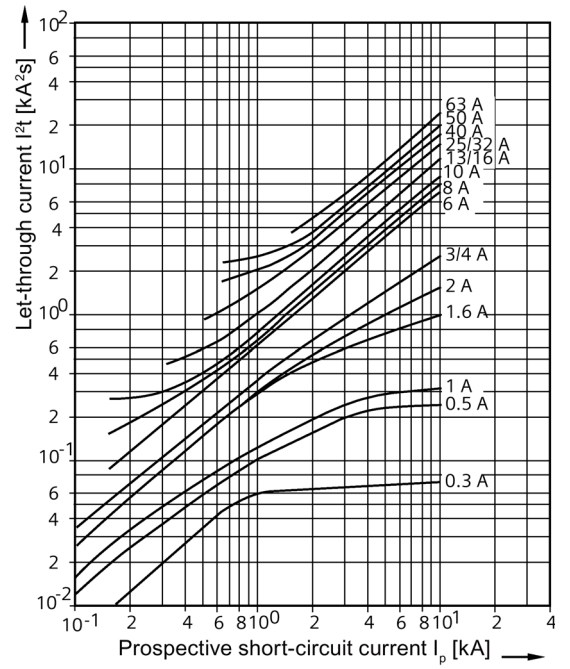

5SY6 (AC)

Characteristic B

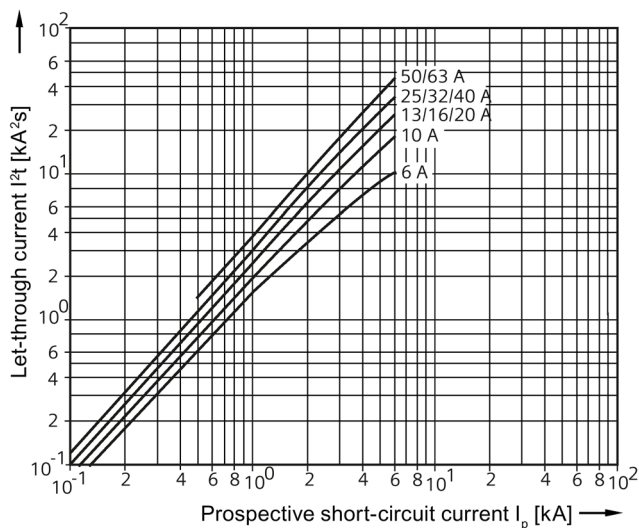

Characteristic C

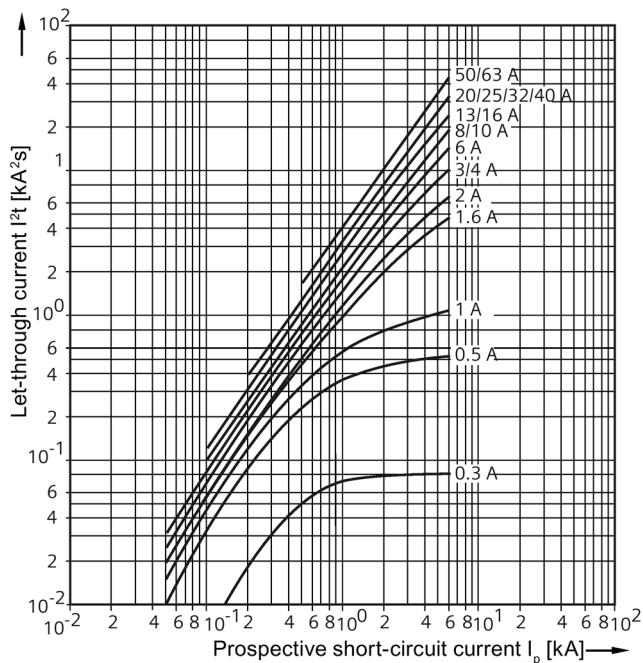

Characteristic curves for let-through I^2t values

5SY7 (AC)

Characteristic B

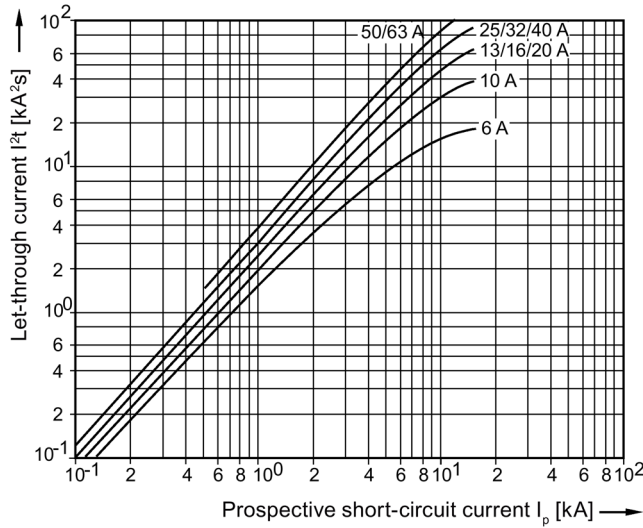

Characteristic C

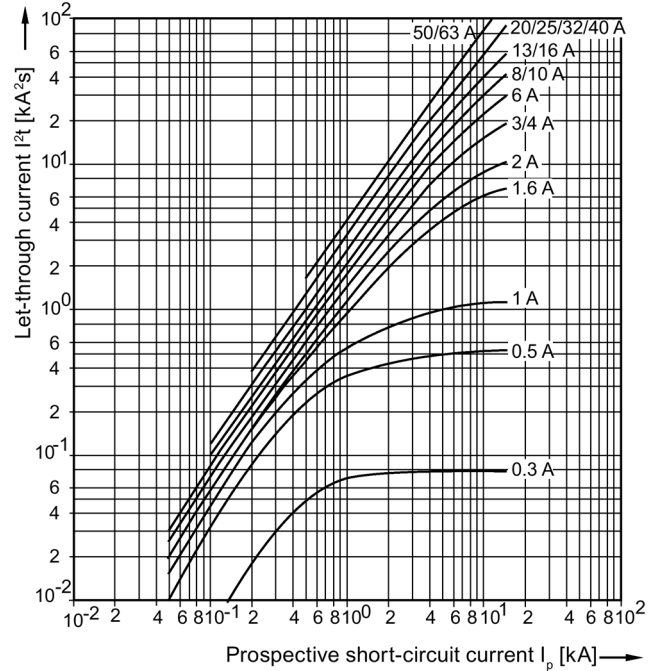

Characteristic D

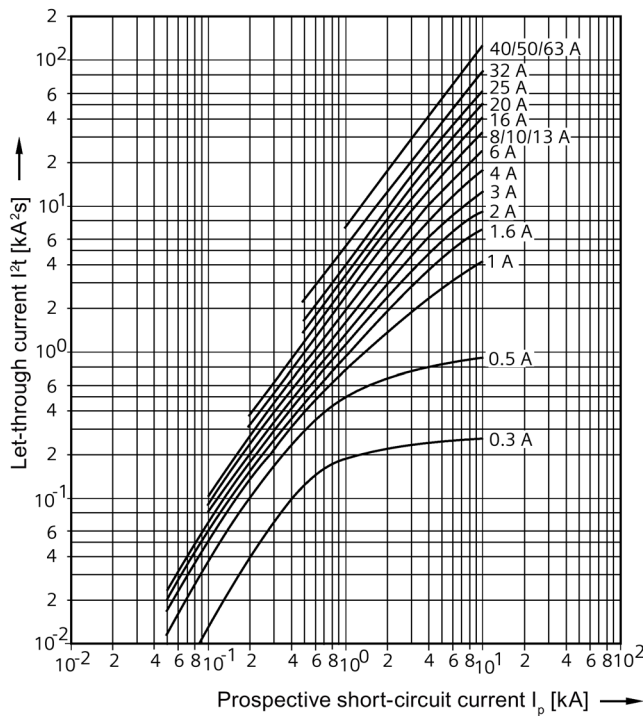

Characteristic curves for let-through I^2t values

5SY8 (AC)

Characteristic C

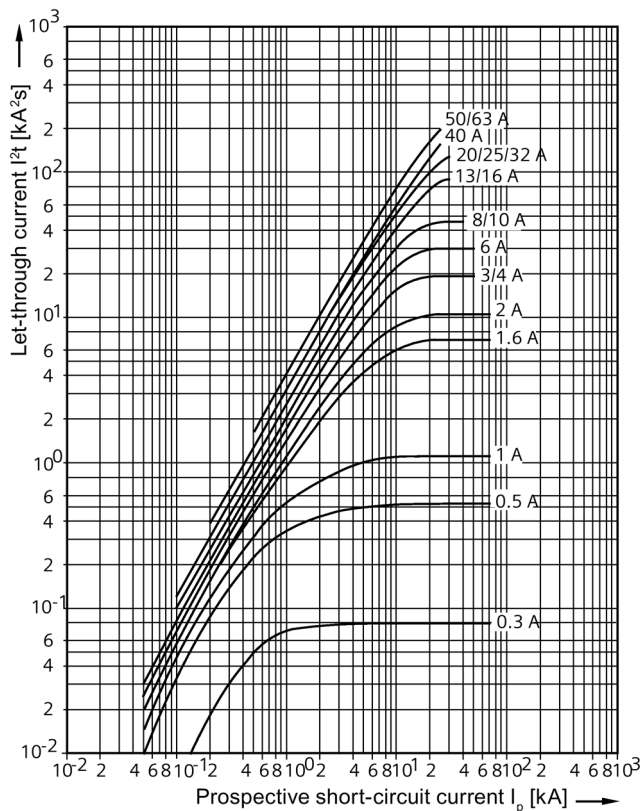

Characteristic D

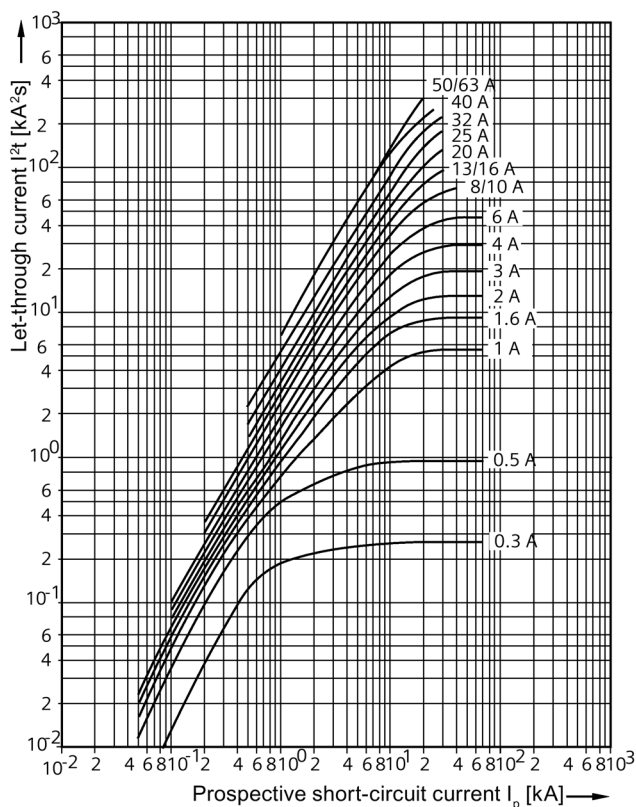

Characteristic curves for let-through I^2t values

5SP4 (AC)

Characteristic B

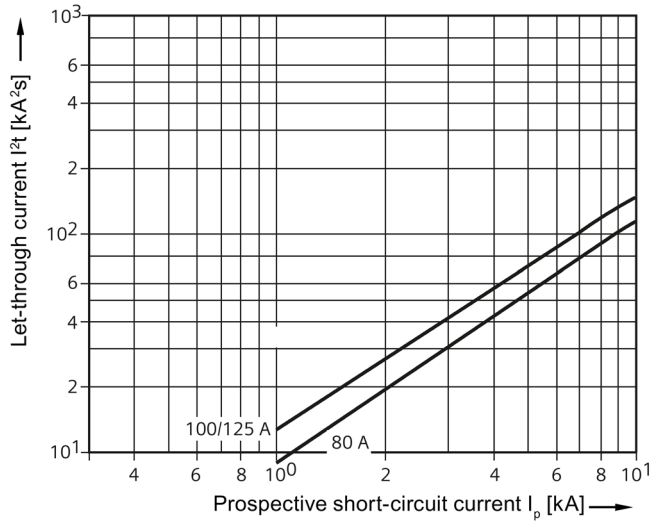

Characteristic C

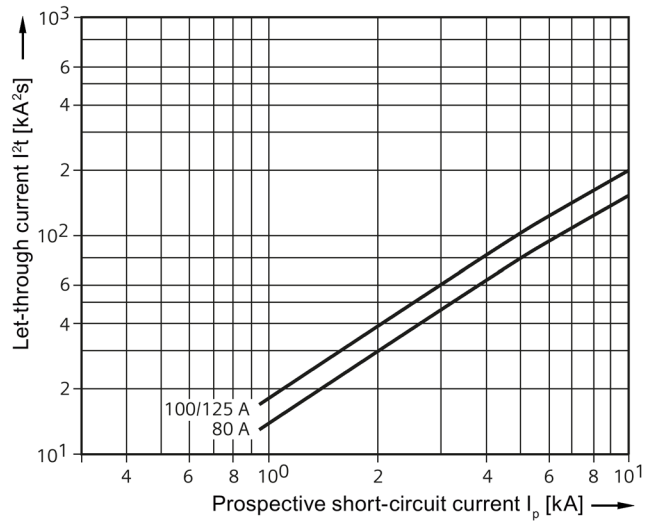

Characteristic D

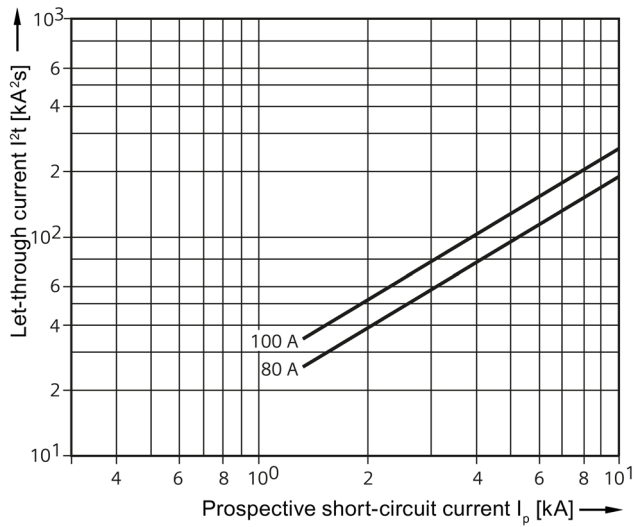

Characteristic curves for let-through I^2t values

5SP5 (AC)

Characteristic C

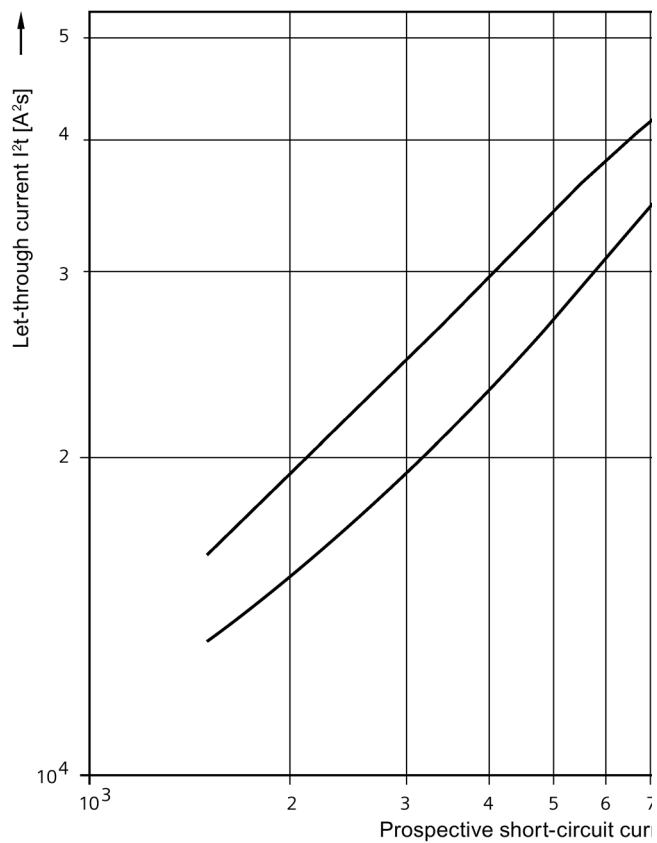

Characteristic curves for let-through I^2t values

5SJ6...-KS (AC)

Characteristic B

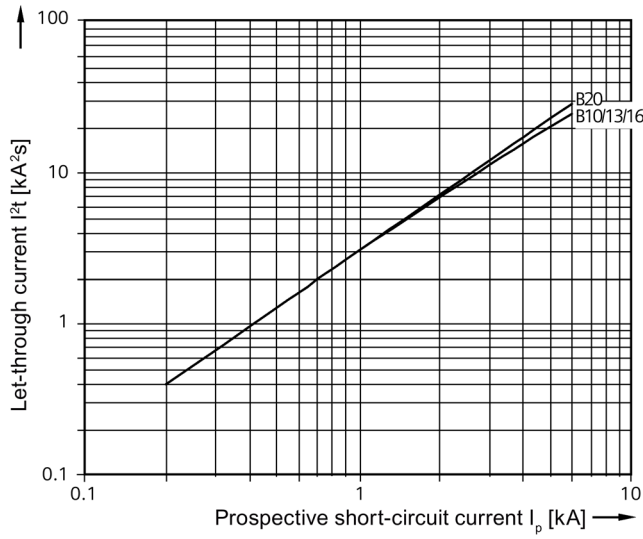

Characteristic C

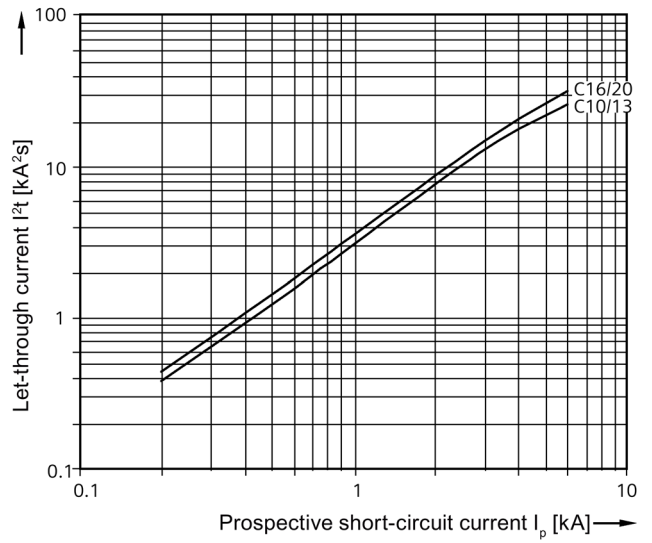

Characteristic curves for let-through I^2t values

5SL30

Characteristic B

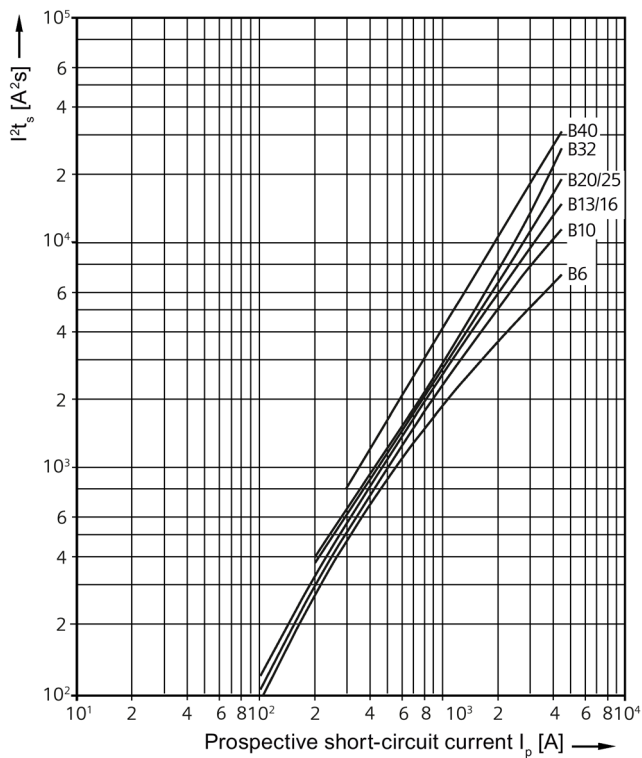

Characteristic C

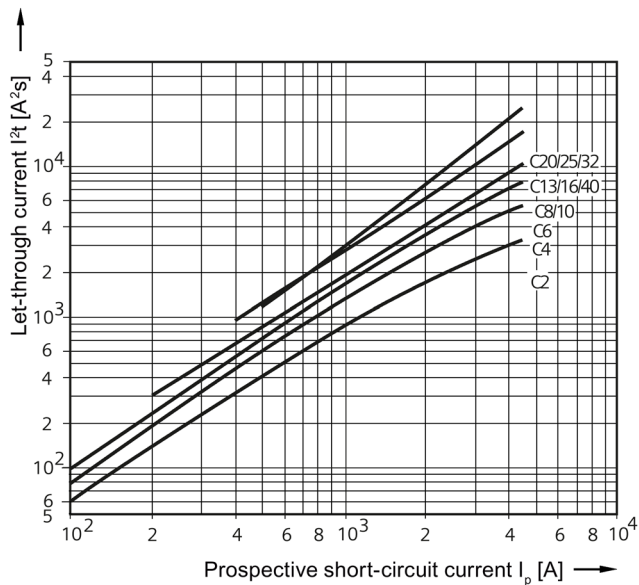

Characteristic curves for let-through I^2t values

5SL60 (AC)

Characteristic B

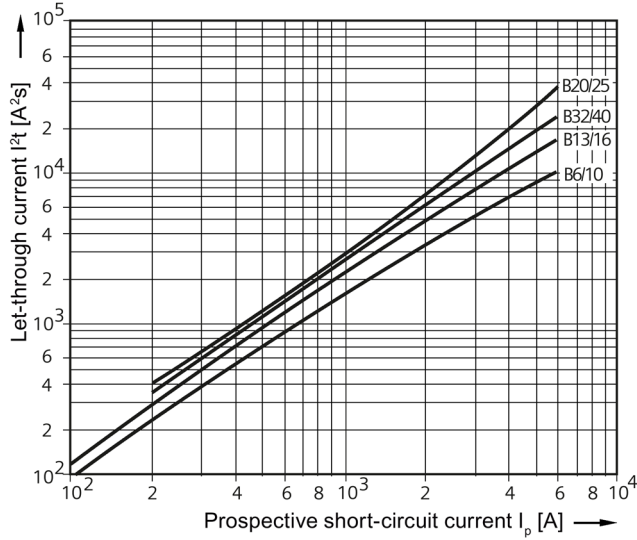

Characteristic C (2 A to 25 A)

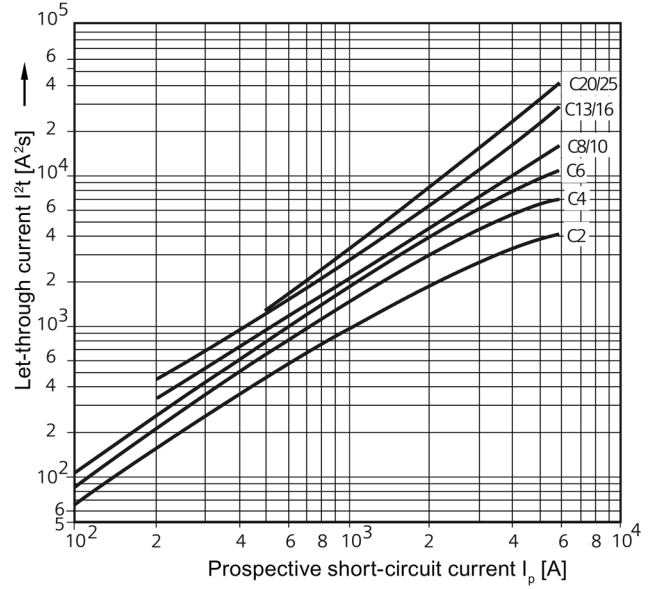

Characteristic C (32 A to 40 A)

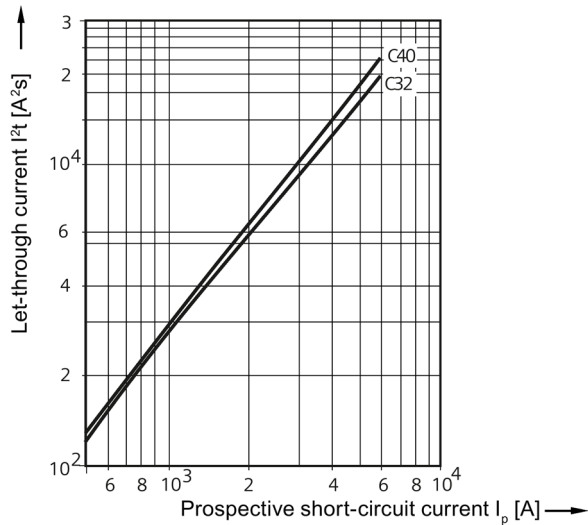

Characteristic curves for let-through I^2t values

5SL6 COM (AC)

Characteristic B

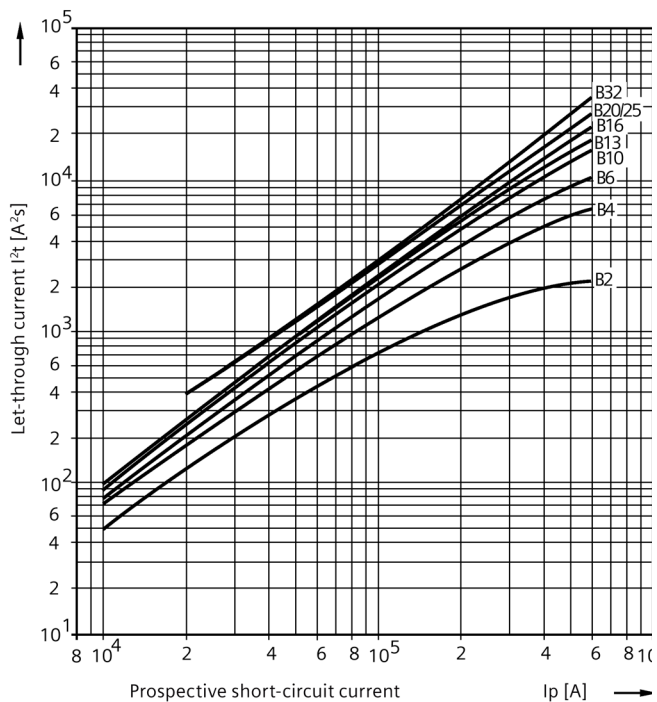

Characteristic C

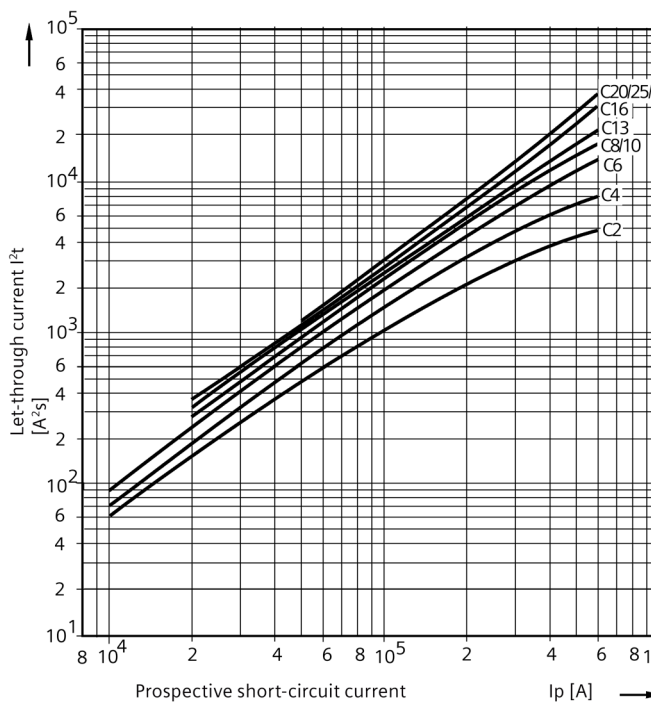

9.2.6 Internal resistance and power loss

9.2.6.1 Miniature circuit breakers 5SL3, 5SL6, without 5SL30... and 5SL60...

Rated current	Characteristic B				Characteristic C			
	1p,2p, 3p, 4p & 1+N	3+N	1p,2p, 3p, 4p & 1+N	3+N	1p,2p, 3p, 4p & 1+N	3+N	1p,2p, 3p, 4p & 1+N	3+N
I_n	R_i		P_v		R_i		P_v	
A	mΩ		W		mΩ		W	
0.3	--		--		10151		0.9	
0.5	--		--		3551		0.9	
1	--		--		11172		1.2	
1.6	--		--		510		1.3	
2	486*	--	1.9*	--	299	297	1.3	1.2
3	--		--		129	127	1.2	1.1
4	102*	--	1.8*	--	82	76	1.3	1.2
6	27.8	52	1	1.9	22.2	43	0.8	1.6
8	--		--		21.9	11.9	1.4	0.8
10	15.5	19.3	1.6	1.9	14	9.1	1.9	0.9
13	11.8	12.3	2	2.1	11	9.1	1.9	1.5
16	7.9	7.1	2	1.8	7	6.4	1.8	1.6
20	5.5	5.7	2.2	2.3	5.4	4.7	2.2	1.9
25	4.4	4.5	2.8		4.1	4.2	2.6	
32	3.6	3.3	3.7	3.4	3.6	3	3.7	3.1
40	2.2		3.4		2.1		3.3	
50	1.6		4.0		1.5		3.8	
63	1.3		5.3		1.3		5.2	5.1

Internal resistance R_i and power loss P_v per pole with I_{Nwarm}

*B2 and B4: only for 1-pole devices

9.2.6.2 5SL60 COM miniature circuit breaker

Rated current	Characteristic B				Characteristic C			
	Phase		N		Phase		N	
	R_i	P_v	R_i	P_v	R_i	P_v	R_i	P_v
I_n	mΩ	W	mΩ	W	mΩ	W	mΩ	W
2	363	1.4	4.2	0.02	284	1.1	2	0.01
4	101	1.6	2.9	0.05	86	1.4	2.9	0.05
6	31	1.1	2.2	0.08	25	0.91	2	0.07
8	--	--	--	--	14	1.3	2.1	0.21
10	18	1.8	2.1	0.21	14	1.3	2.1	0.21
13	10	1.7	2	0.34	10	1.7	2	0.35
16	9.3	2.4	2.1	0.53	8.3	2.1	2	0.5
20	7.7	3.1	1	0.4	8.2	3.3	1	0.4
25	5.5	3.4	1	0.63	5.5	3.4	1	0.63
32	4.7	4.8	0.9	0.9	4.5	4.6	1	1

Internal resistance R_i and power loss P_v per pole with I_{nwarm}

9.2.6.3 5SL4 miniature circuit breakers

Rated current	Characteristic B		Characteristic C		Characteristic D	
	R_i	P_v	R_i	P_v	R_i	P_v
	mΩ	W	mΩ	W	mΩ	W
0.3	--	--	10151	0.9	10151	0.9
0.5	--	--	3551	0.9	3551	0.9
1	1954	2.0	1172	1.2	1089	1.1
1.6	--	--	510	1.3	466	1.2
2	461	1.8	297	1.2	273	1.1
3	216	1.9	127	1.1	124	1.1
4	98	1.6	76	1.2	68	1.1
6	52	1.9	43	1.6	39	1.4
8	22	1.4	11.9	0.8	11.8	0.8
10	19.3	1.9	9.1	0.9	8.6	0.9
13	12.3	2.1	9.1	1.5	8.2	1.4
16	7.1	1.8	6.0	1.5	4.8	1.2
20	6.1	2.5	5.0	2.0	4.1	1.6
25	4.8	3.0	3.7	2.3	3.7	2.3
32	2.6	2.7	2.6	2.6	2.6	2.7
40	2.2	3.4	2.1	3.3	2.1	3.3
50	1.6	4.0	1.4	3.6	1.4	3.6
63	1.3	5.0	1.3	5.0	1.3	5.0

Internal resistance R_i and power loss P_v per pole with I_{nwarm}

9.2.6.4 5SY4, 5SY6, 5SY7, 5SY8, 5SY5, 5SP4 and 5SP5 miniature circuit breakers

Rated current I_n A	Characteristic A		Characteristic B		Characteristic C		Characteristic D	
	R_i mΩ	P_v W	R_i mΩ	P_v W	R_i mΩ	P_v W	R_i mΩ	P_v W
0.3	--	--	--	--	10270	0.9	10070	1
0.5	7600	1.9	--	--	3300	0.8	3100	0.8
1	2080	2.1	--	--	1200	1.2	1075	1.1
1.6	831	2.1	--	--	450	1.2	408	1.0
2	546	2.2	381	1.5	298	1.2	295	1.2
2.5	--	--	--	--	230	1.4	--	--
3	213	1.9	--	--	138	1.3	132	1.2
3.5	--	--	--	--	135	1.7	--	--
4	144	2.3	93	1.5	81	1.3	74	1.2
5	--	--	--	--	87	2.2	--	--
6	60	2.2	58	2.1	45	1.6	44	1.6
8	29.3	1.9	--	--	14	0.9	12	0.8
10	--	2.0	13	1.3	11	1.0	8.5	0.9
13	11.7	2.0	9.9	1.7	8.3	1.4	8.3	1.4
15	--	--	--	--	6.5	1.5	--	--
16	9.6	2.5	6.9	1.8	6.3	1.6	6.2	1.6
20	6.2	2.5	5.5	2.2	4.3	1.7	4.0	1.6
25	5.2	3.3	3.8	2.4	3.5	2.2	3.3	2.1
30	--	--	--	--	2.6	2.3	--	--
32	3.3	3.4	2.5	2.6	2.6	2.6	2.1	2.1
35	--	--	--	--	2.1	2.6	--	--
40	2.4	3.9	2.2	3.6	2.2	3.5	1.9	3.0
45	--	--	--	--	1.5	3.1	--	--
50	1.8	4.5	1.7	4.3	1.5	3.8	1.5	3.7
60	--	--	--	--	1.2	4.4	--	--
63	1.5	6.0	1.5	6.0	1.2	4.9	1.3	5.0
80	--	--	1.05	6.7	1.05	6.7	--	--

Internal resistance R_i and power loss P_v per pole with I_{Nwarm}

9.2.6.5 5SP4 and 5SP5 miniature circuit breakers

Rated current	Characteristic A		Characteristic B		Characteristic C		Characteristic D	
	R_i	P_v	R_i	P_v	R_i	P_v	R_i	P_v
A	mΩ	W	mΩ	W	mΩ	W	mΩ	W
80	--	--	1.1	7.0	7	6.7	1.1	7
100	--	--	0.8	8.0	0.8	8	0.8	8
125	--	--	0.7	10.9	0.7	10.9	--	--

Correction factors for power loss

- Direct current and alternating current up to 60 Hz × 1.0
- Alternating current
 - 200 Hz × 1.1
 - 400 Hz × 1.15
 - 1000 Hz × 1.3

9.2.6.6 5SL30, 5SL60 miniature circuit breakers, compact range 1+N in 1 MW

Rated current	Characteristic B				Characteristic C			
	Phase-pole		N pole		Phase-pole		N pole	
I_n	R_i	P_v	R_i	P_v	R_i	P_v	R_i	P_v
A	mΩ	W	mΩ	W	mΩ	W	mΩ	W
2	--	--	--	--	330	1.293	4.8	0.02
4	--	--	--	--	130	2.1	4.8	0.08
6	32	1.2	4.8	0.17	39	1.4	4.8	0.17
8	--	--	--	--	20	1.3	4.8	0.31
10	19	1.9	4.8	0.48	13	1.3	4.8	0.48
13	13	2.2	4.8	0.81	9.5	1.6	4.8	0.81
16	9.1	2.3	4.8	1.2	8.1	2.1	4.8	1.2
20	6.3	2.5	4.8	1.9	5.6	2.2	4.8	1.9
25	3.5	2.2	1.3	0.81	3.3	2.1	1.3	0.81
32	2.7	2.8	1.9	1.9	2.8	2.8	1.9	1.9
40	2.5	4.0	1.9	3.0	2.4	3.8	1.9	3.0

Internal resistance R_i and power loss P_v per pole with I_{Nwarm}

9.2.7 Characteristic curves for personnel safety with miniature circuit breakers

5SL, 5S, 5SP miniature circuit breakers

Maximum permissible impedance of fault loop at $U_0 = 230$ V AC for compliance with trip conditions according to DIN VDE 0100-410

Rated current I_n	Characteristic A		Characteristic B		Characteristic C		Characteristic D	
	$t_a \leq 0.4$ s	≤ 5 s	$t_a \leq 0.4$ s	≤ 5 s	$t_a \leq 0.4$ s	≤ 5 s	$t_a \leq 0.4$ s	≤ 5 s
A	Ω	Ω	Ω	Ω	Ω	Ω	Ω	Ω
0.3	--	--	--	--	76.6	153	--	--
0.5	--	--	--	--	46	92	--	92
1	76.6	76.6	--	--	23	46	15.3	46
1.6	47.9	47.9	--	--	14.4	28.8	9.6	28.8
2	38.3	38.3	--	--	11.5	23	7.6	23
3	25.5	25.5	--	--	7.7	15.4	5.1	15.4
4	19.1	19.1	--	--	5.8	11.6	3.8	11.6
6	12.7	12.7	7.6	7.6	3.8	7.6	2.5	7.6
8	--	--	--	--	2.8	5.7	1.9	5.7
10	7.6	7.6	4.6	4.6	2.3	4.6	1.1	4.6
13	--	--	--	3.57	1.7	3.4	0.9	3.4
16	4.7	4.7	2.9	2.9	1.4	2.8	0.7	2.8
20	3.8	3.8	2.3	2.3	1.1	2.2	0.5	2.2
25	3.0	3.0	1.8	1.8	0.9	1.8	0.3	1.8
32	2.4	2.4	1.4	1.4	0.7	1.4	0.28	1.4
40	1.9	1.9	1.1	1.1	0.6	1.2	0.28	1.2
50	--	--	0.9	0.9	0.5	1.0	0.23	1.0
63	--	--	0.7	0.7	0.4	0.8	0.2	0.8
80	--	--	--	--	0.3	0.6	0.14	0.6
100	--	--	--	--	0.2	0.4	0.1	0.4
125	--	--	--	--	0.16	0.3	0.1	0.3

At $U_0 = 240$ V AC, $Z_s \times 1.04$ applies.

At $U_0 = 127$ V AC, $Z_s \times 0.55$ applies.

9.2.8 Personnel safety with miniature circuit breakers

According to DIN VDE 0100-410, in order to protect against dangerous leakage currents in the TN system, the cross-sections of the conductor, or its distance from the protective device, must be dimensioned such that if a fault with negligible impedance (i.e. short-circuit) occurs at any point between a phase conductor and a PE conductor, or a connected exposed conductive part, the device automatically trips within the specified times of 0.4 s/5 s.

This requirement is met through the following condition:

$$Z_s \times I_a \leq U_o$$

Z_s \triangleq Impedance of the fault loop of all electrical circuits

I_a \triangleq Current that trips within the specified times

U_o \triangleq Voltage to ground

9.2.9 Fuse protection of luminaire circuits

Maximum permissible lamp load of a miniature circuit breaker when operating fluorescent lamps L 18 W, L 36 W, L 38 W, L 58 W.

Table 9- 1 Maximum number of fluorescent lamps

I_n [A]	Lamp	Electronic ballast											
		Full switching at 230 V						Group switching at 230 V					
		1 lamp ¹⁾			2 lamps			1 lamp ¹⁾			2 lamps		
5SY4, 5SY6, 5SY7, 5SY8, 5SY5													
	Characteristic	B	C	D	B	C	D	B	C	C	B	C	D
6	L 18 W	17	37	66	17	35	35	66	66	66	35	35	35
	L 36 W	17	37	37	17	19	19	37	37	37	19	19	19
	L 58 W	17	19	19	12	12	12	19	19	19	12	12	12
8	L 18 W	--	50	88	--	47	47	--	88	88	--	--	47
	L 36 W	--	50	50	--	25	25	--	50	50	--	25	25
	L 58 W	--	25	25	--	16	16	--	25	25	--	16	16
10	L 18 W	36	67	111	36	58	58	111	111	111	58	58	58
	L 36 W	36	62	62	32	32	32	62	62	62	32	32	32
	L 58 W	32	32	32	20	20	20	32	32	32	20	20	20
13	L 18 W	44	81	144	44	76	76	144	144	144	76	76	76
	L 36 W	44	81	81	41	41	41	81	81	81	41	41	41
	L 58 W	41	41	41	26	26	26	41	41	41	26	26	26
16	L 18 W	56	100	177	56	94	94	177	177	177	94	94	94
	L 36 W	56	100	100	51	51	51	100	100	100	51	51	51
	L 58 W	51	51	51	32	32	32	51	51	51	32	32	32
20	L 18 W	70	117	222	70	117	117	222	222	222	117	117	117
	L 36 W	70	117	125	64	64	64	125	125	125	64	64	64
	L 58 W	64	64	64	40	40	40	64	64	64	40	40	40
25	L 18 W	85	157	277	85	147	147	277	277	277	147	147	147
	L 36 W	85	156	156	80	80	80	156	156	156	80	80	80
	L 58 W	80	80	80	51	51	51	80	80	80	51	51	51
32	L 18 W	100	144	355	100	144	188	355	355	355	188	188	188
	L 36 W	100	144	200	100	103	103	200	200	200	103	103	103
	L 58 W	100	103	103	65	65	65	103	103	103	65	65	65
40	L 18 W	126	216	444	126	216	235	444	444	444	235	235	235
	L 36 W	126	216	250	126	129	129	250	250	250	129	129	129
	L 58 W	126	129	129	81	81	81	129	129	129	81	81	81
50	L 18 W	180	247	555	180	247	294	555	555	555	294	294	294
	L 36 W	180	247	312	161	161	161	312	312	312	161	161	161
	L 58 W	161	161	161	102	102	102	161	161	161	102	102	102
63	L 18 W	170	340	567	170	340	370	700	700	700	370	370	370
	L 36 W	170	340	393	170	203	203	393	393	393	203	203	203
	L 58 W	170	203	203	128	128	128	203	203	203	128	128	128

9.2 Characteristic curves

I_n [A]	Lamp	Electronic ballast
-----------	------	--------------------

- 1) All ECGs are turned on simultaneously.
- 2) The ECGs are turned on in groups one after the other.

Circuit impedance: The specified lamp loads apply, taking into account a line impedance of 800 mΩ. At 400 mΩ, the permissible values are reduced by 10%.

Table 9- 2 Reduction factors for miniature circuit breakers for the simultaneous switching on of incandescent lamp loads, with reference to the rated current of the miniature circuit breaker and the total operational current of the lamps

	Reduction factor	
	Switching with miniature circuit breaker	Switching with separate switch
5SL, 5SY, 5SP4		
Characteristic A	0.3	0.35
Characteristic B	0.5	0.6
Characteristic C	1	1
Characteristic D	1	1

Table 9- 3 Current-carrying capacity of miniature circuit breakers with corrected and uncorrected HQ, HQI and NAV lamps (number)

		Lamp power [W]							
		35	70	150	250	400	1000	2000	3500
Lamp current	[A]	0.5	1	1.8	3	3.5	9.5	10.3	18
Corrected lamp current	[A]	0.3	0.5	1	1.5	2	6	5.5	9.8
Inrush peak	[A]	10	18	36	60	70	120	125	220

Table 9- 4 Current-carrying capacity of miniature circuit breakers with corrected and uncorrected HQ, HQI and NAV lamps (number)

	I_n [A]	Lamp power [W]							
		35	70	150	250	400	1000	2000	3500
5SY4...-6, 5SY6...-6, 5SY7...-6									
Characteristic B	6	2	1	0	0	0	0	0	0
	10	5	3	1	1	0	0	0	0
	13	7	4	2	1	1	0	0	0
	16	8	5	2	1	1	0	0	0
	20	11	6	3	1	1	1	1	0
	25	13	7	3	2	2	1	1	0
	32	16	8	4	2	2	1	1	0
	40	20	11	5	3	3	1	1	1
	50	28	15	7	4	4	2	2	1
63	26	14	7	4	3	2	2	1	
5SY4...-7, 5SY6...-7, 5SY7...-7									
Characteristic C	6	6	3	1	1	0	0	0	0
	8	8	4	2	1	1	0	0	0
	10	10	6	3	1	1	0	0	0
	13	13	7	3	2	1	1	1	0
	16	16	9	4	2	2	1	1	0
	20	18	10	5	3	2	1	1	0
	25	25	14	7	4	3	2	1	1
	32	22	12	6	3	3	2	1	1
	40	33	18	9	5	4	2	2	1
	50	38	21	10	6	5	3	3	2
63	53	29	14	9	7	4	4	2	
5SY4...-8, 5SY7...-8									
Characteristic D	6	8	4	2	1	1	0	0	0
	8	11	5	3	2	1	0	0	0
	10	14	7	4	2	2	0	0	0
	13	18	9	5	3	2	1	1	0
	16	22	11	6	3	3	1	1	0
	20	28	14	7	4	4	1	1	0
	25	35	17	9	5	5	2	1	1
	32	44	22	12	7	6	2	2	1
	40	56	28	15	9	8	3	2	1
	50	70	35	19	11	10	4	3	2
63	88	44	24	14	12	4	4	2	

	I_n [A]	Lamp power [W]							
5SP4...-7									
Characteristic C	80	76	42	21	12	11	6	6/5	3
	100	98	54	27	16	14	8/7	8/6	4
	125	116	64	32	19	16	9	9/8	5
5SP4...-8									
Characteristic D	80	143/112	80/56	40/31	24/18	20/16	9/6	10/5	5/3
	100	186/140	103/70	51/39	31/23	26/20	11/7	12/6	7/4

Different data applies for corrected/uncorrected lamps.

9.2.10 DC applications

DC applications up to 60 V DC rated voltage (max. 72 V DC operating voltage)

The 5SL, 5SY, 5SP4 and 5SJ4...HG.. miniature circuit breakers can also be used in DC systems. The max. operating voltage per phase pole must not exceed 72 V DC.

With a series connection of two or more poles, a multiple of this can be achieved depending on the circuit, e.g. max. 144 V DC with a series connection of two poles. However, depending on the overall circuit, it must always be ensured that the rated voltage of 60 V DC per pole or the max. operating voltage of 72 V DC per phase pole is not exceeded.

Line system	Single-ended grounding	Single-ended grounding	Neutral point symmetrically grounded	Insulated / Not grounded
Circuit diagram	<p>$U_{max} = 72 \text{ V DC}$</p>	<p>$U_{max} = 144 \text{ V DC}$</p>	<p>$U_{max} = 144 \text{ V DC}$</p>	<p>$U_{max} 72 \text{ V DC}$</p>
Fault types	<p>a In the event of a fault between the positive and negative poles, the maximum short-circuit current from both poles of the source is supplied with the full voltage U_{max} and protected by the miniature circuit breaker.</p>	-	<p>In the event of a fault between the positive and negative poles, the maximum short-circuit current from both poles of the source is supplied with the full voltage U_{max} and protected by the miniature circuit breaker.</p>	<p>In the event of a fault between the positive and negative poles, the maximum short-circuit current from both poles of the source is supplied with the full voltage U_{max} and protected by the miniature circuit breaker.</p>

b	In the event of a fault between the non-grounded pole and ground, the maximum short-circuit current from both poles of the source is supplied with the full voltage U_{max} and protected by the miniature circuit breaker.	-	In the event of a fault between the positive pole and ground, the maximum short-circuit current is supplied with a voltage of $0.5 \times U_{max}$ and is only protected by the poles of the miniature circuit breaker connected in the positive pole.	A first fault between pole and ground has no consequences for this circuit. However, this fault can have an influence on the entire installation (insulation fault).
c	A first fault between pole and ground has no consequences for this circuit. However, this fault can have an influence on the entire installation (insulation fault).	In the event of a fault between the non-grounded pole and ground, the maximum short-circuit current from both poles of the source is supplied with the full voltage U_{max} and protected by the miniature circuit breaker.	See fault b, but concerns only the negative pole.	A first fault between pole and ground has no consequences for this circuit. However, this fault can have an influence on the entire installation (insulation fault).
Circuit	The poles of the miniature circuit breaker which are required for protection must be connected in series to the non-grounded pole. If the positive pole is grounded, the negative pole must be protected. If an isolating function is required, the grounded pole must also be protected.	The poles of the miniature circuit breaker which are required for protection must be connected in series to the non-grounded pole. If the positive pole is grounded, the negative pole must be protected. If an isolating function is required, the grounded pole must also be protected.	The miniature circuit breaker must be provided at the positive and negative pole to cut off the short-circuit current at $0.5 \times U_{max}$.	The positive and negative poles must be protected with the appropriate number of poles of the circuit breaker.

① Connection must be short-circuit proof

 Load (e.g. inverter)

 Power supply (e.g. solar panel, battery)



DC applications for higher voltage

For higher DC voltages, universal current (UC) miniature circuit breakers of version 5SY5 are recommended, which can be used for both AC and DC applications.

The maximum voltage for 5SY5 AC-DC devices is 250 V DC per phase pole. By connecting the individual poles in series, the 4-pole devices, for example, can be used up to a maximum of 1000 V DC.

The arcing chamber area of the 5SY5 miniature circuit breakers is equipped with additional permanent magnets to support the positive quenching of the electric arc. For this reason, the polarity of the breakers is marked. It is therefore essential to pay attention to the direction of current flow when connecting the conductors. Suitable precautions should be taken during plant configuration to ensure there can be no polarity reversal in DC operation (e.g. photovoltaic plants).

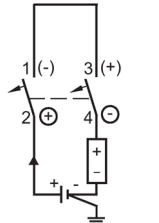
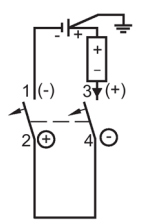
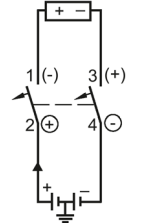
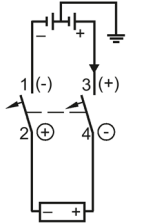
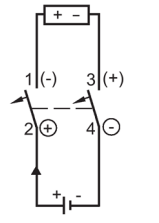
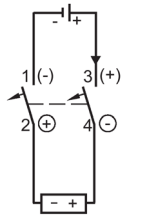
Line system	Single-ended grounding		Neutral point symmetrically grounded		Insulated / Not grounded									
Circuit diagram														
Fault types														
a	In the event of a fault between the positive and negative poles, the maximum short-circuit current from both poles of the source is supplied with the full voltage U_{max} and protected by the miniature circuit breaker.		In the event of a fault between the positive and negative poles, the maximum short-circuit current from both poles of the source is supplied with the full voltage U_{max} and protected by the miniature circuit breaker.		In the event of a fault between the positive and negative poles, the maximum short-circuit current from both poles of the source is supplied with the full voltage U_{max} and protected by the miniature circuit breaker.									
b	In the event of a fault between the non-grounded pole and ground, the maximum short-circuit current from both poles of the source is supplied with the full voltage U_{max} and protected by the miniature circuit breaker.		In the event of a fault between the positive pole and ground, the maximum short-circuit current is supplied with a voltage of $0.5 \times U_{max}$ and is only protected by the poles of the miniature circuit breaker connected in the positive pole.		A first fault between pole and ground has no consequences for this circuit. However, this fault can have an influence on the entire installation (insulation fault).									
c	A first fault between pole and ground has no consequences for this circuit. However, this fault can have an influence on the entire installation (insulation fault).		See fault b, but concerns only the negative pole.		A first fault between pole and ground has no consequences for this circuit. However, this fault can have an influence on the entire installation (insulation fault).									
Circuit	The poles of the miniature circuit breaker which are required for protection must be connected in series to the non-grounded pole. If the positive pole is grounded, the negative pole must be protected. If an isolating function is required, the grounded pole must also be protected.		The miniature circuit breaker must be provided at the positive and negative pole to cut off the short-circuit current at $0.5 \times U_{max}$.		The positive and negative poles must be protected with the appropriate number of poles of the circuit breaker.									
U_{max}	1-pole disconnection		2-pole/all-pole disconnection		2-pole/all-pole disconnection									
≤ 250 V														
	-pole grounded, infeed at bottom		+pole grounded, infeed at top		Infeed at bottom		Infeed at top		Infeed at bottom		Infeed at bottom			

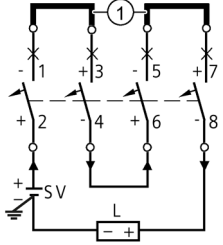
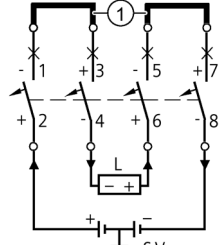
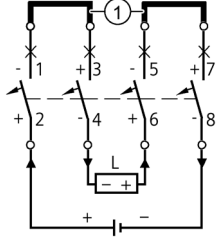
<p>≤ 500 V</p> 	 <p>-pole grounded, infeed at bottom</p>	 <p>+pole grounded, infeed at top</p>	 <p>Infeed at bottom</p>	 <p>Infeed at top</p>	 <p>Infeed at bottom</p>	 <p>Infeed at bottom</p>
<p>≤ 1000 V</p> 	 <p>Infeed at bottom</p>	 <p>Infeed at bottom</p>	 <p>Infeed at bottom</p>			

① Connection must be short-circuit proof

 Load (e.g. inverter)

 Power supply (e.g. solar panel, battery)

9.3 Selectivity

Distribution systems are usually set up as radial systems. An overcurrent protection device is required for each reduction of the conductor cross-section. This produces a series connection staggered according to rated currents, which should, if possible, be "selective". Selectivity means that, in the event of a fault, only the protective device that is directly next to the fault in the current circuit is tripped. This means that current paths in parallel can maintain a power flow.

In the case of miniature circuit breakers with upstream fuses, the selectivity limit depends largely on the current limitation and tripping characteristics of the miniature circuit breaker and the melting I_{2t} value of the fuse. In fuseless distribution networks, a circuit breaker or miniature circuit breaker acts as an upstream protective device. In this case, the selectivity limit depends on the level of peak current I^{\wedge} let through by the miniature circuit breaker and the tripping current of the circuit breaker.

This produces different selectivity limits for miniature circuit breakers with different characteristics and rated switching capacity.

The following selectivity tables provide information on the short-circuit currents up to which selectivity is ensured between miniature circuit breakers and upstream fuses or, in fuseless distribution boards, for upstream molded case circuit breakers or more powerful miniature circuit breakers. The values specified in kA are limit values that were determined under unfavorable test conditions. Under normal practical conditions, you can often expect considerably better values, depending on the type of upstream protective device.

9.3.1 Selectivity of miniature circuit breakers/fuses

The following tables provide information on the short-circuit currents up to which selectivity exists between miniature circuit breakers and upstream fuses according to DIN VDE 0636-2. The values specified in kA are limit values that were determined under unfavorable test conditions. Under normal practical conditions, you can often expect considerably better values, depending on the upstream fuses.

More information

Technical specifications are available on the internet
(<https://support.industry.siemens.com/cs/ww/en/view/109748621>)

9.3.2 Selectivity of miniature circuit breakers/miniature circuit breakers

Within narrow limits, miniature circuit breakers also offer selectivity to each other in a fuseless distribution board. The following table shows the short-circuit current in kA up to which there is selectivity between series-connected miniature circuit breakers at 230 V AC. This depends on the let-through peak current \hat{I} of the downstream miniature circuit breaker and on the tripping current of the upstream miniature circuit breaker.

Selectivity limit values of miniature circuit breakers/miniature circuit breakers in kA

Downstream miniature circuit breakers			Upstream miniature circuit breakers										
			5SY4...-7 Characteristic C						5SP4...-7 Characteristic C		5SP4...-8 Characteristic D		
			I _n [A]	20	25	32	40	50	63	80	100	80	100
			I _{cu} [kA]	20			15			10			
			I _i [A]	200	250	320	400	500	630	800	1000	1600	2000
I _n [A] ¹⁾	I _{cn} [kA]	Selectivity limits [kA]											
5SY -6 (without 5SY.0), 5SJ4...-6HG40²⁾													
Characteristic B	6	6/10/15	0.2	0.2	0.3	0.5	0.5	0.6	0.8	1.5	3	5	
	10	6/10/15	0.2	0.2	0.3	0.5	0.5	0.6	0.8	1.2	3	4	
	13	6/10/15	0.2	0.2	0.3	0.4	0.5	0.5	0.8	1.2	2	3	
	16	6/10/15	0.2	0.2	0.3	0.4	0.5	0.5	0.8	1.2	2	3	
	20	6/10/15	--	0.2	0.3	0.4	0.5	0.5	0.8	1.2	2	3	
	25	6/10/15	--	--	--	0.4	0.4	0.6	0.6	1.2	1.5	3	
	32	6/10/15	--	--	--	0.4	0.4	--	0.6	1.2	1.5	3	
	40	6/10/15	--	--	--	--	0.4	--	0.6	1.2	1.5	2.5	
50	6/10/15	--	--	--	--	--	--	0.6	1	1.5	2.5		
5SY -7 (without 5SY.0), 5SJ4...-7HG..²⁾													
Characteristic C	0.5	6/10/15	0.2	0.3	0.5	0.8	0.8	0.8	1.2	4	T	T	
	1	6/10/15	0.2	0.3	0.5	0.8	0.8	0.8	1.2	4	T	T	
	1.5	6/10/15	0.2	0.3	0.5	0.8	0.8	0.8	1.2	4	T	T	
	2	6/10/15	0.2	0.3	0.5	0.8	0.8	0.8	1.2	4	T	T	
	3	6/10/15	0.2	0.2	0.3	0.5	0.5	0.8	0.8	1.5	3	4	
	4	6/10/15	0.2	0.2	0.3	0.5	0.5	0.6	0.8	1.5	3	4	
	6	6/10/15	0.2	0.2	0.3	0.5	0.5	0.6	0.8	1.5	3	4	
	8	6/10/15	0.2	0.2	0.3	0.4	0.4	0.6	0.6	1.2	2.5	3	
	10	6/10/15	0.2	0.2	0.3	0.4	0.4	0.6	0.6	1.2	2.5	3	
	13	6/10/15	0.2	0.2	0.3	0.4	0.4	0.5	0.6	1.2	2	3	
	16	6/10/15	0.2	0.2	0.3	0.4	0.4	0.5	0.6	1.2	2	3	
	20	6/10/15	--	0.2	0.3	0.4	0.4	0.5	0.6	1.2	2	3	
	25	6/10/15	--	--	--	0.3	0.4	0.5	0.6	1	1.5	2.5	
	32	6/10/15	--	--	--	0.3	0.4	--	0.6	1	1.5	2.5	
	40	6/10/15	--	--	--	--	--	--	--	0.8	1.5	2	
50	6/10/15	--	--	--	--	--	--	--	0.8	1.5	2		
63	6/10/15	--	--	--	--	--	--	--	0.8	1.2	1.5		

T ≙ full selectivity up to I_{cu}/I_{cn} rated short-circuit breaking capacity of the downstream protective device.

- 1) In 240/415 V, 50 Hz systems, the selectivity limits are reduced by 10%. The selectivity limits for adjustable releases apply to the maximum value, I_n = rated current. I_i r tripping current.
- 2) The values specified for 5SJ4...-HG.. are not according to UL but are the manufacturer's specifications according to EN 60947-2 and apply for voltage U_e= 230 V ~. For available rated currents, see Catalog LV 10.

Selectivity limit values of miniature circuit breakers/miniature circuit breakers in kA

		Selectivity of the 5SL4... for the upstream miniature circuit breaker 5SP4... [kA]				
Miniature Circuit Breakers		5SP4				
Characteristic		C			D	
Rated breaking capacity		10				
Rated current		I_n [A] ¹⁾				
		80	100	125	80	100
Circuit breaker type: 5SL4...-. Characteristic B I_{cn} [kA] = 10	1	T	T	T	T	T
	2	T	T	T	T	T
	3	2.2	T	T	T	T
	4	1.2	2.6	2.9	6.6	9.7
	6	1	2.1	2.3	4.3	6.9
	8	0.9	1.8	2	3.3	4.6
	10	0.9	1.6	1.7	2.8	4
	13	0.8	1.4	1.6	2.6	3.6
	16	0.7	1.3	1.4	2.3	3
	20	0.7	1.2	1.3	2.1	2.8
	25	0.7	1.1	1.2	2	2.7
	32	0.6	1	1.1	1.8	2.4
	40	0.6	1	1.1	1.8	2.4
	50	0.6	1	1	1.6	2.1
	63	0.6	0.9	1	1.5	2
Circuit breaker type: 5SL4...-. Characteristic C I_{cn} [kA] = 10	0.3	T	T	T	T	T
	0.5	T	T	T	T	T
	1	T	T	T	T	T
	1.6	3.1	T	T	T	T
	2	1.6	3.9	4.5	T	T
	3	1.2	2.5	2.8	6	8.9
	4	1	2.1	2.4	4.4	7
	6	0.9	1.6	1.8	3	4.5
	8	0.7	1.2	1.2	2	2.7
	10	0.7	1.2	1.2	2	2.7
	13	0.7	1.2	1.2	2	2.7
	16	0.7	1.2	1.2	2	2.7
	20	0.6	1	1.1	1.8	2.4
	25	0.6	1	1.1	1.8	2.4
	32	0.6	0.9	1	1.6	2.2
40	0.6	0.9	1	1.6	2.2	
50	--	0.9	0.9	1.5	2	
63	--	0.9	0.9	1.5	2	
Circuit breaker type: 5SL4...-. Characteristic D I_{cn} [kA] = 10	0.3	T	T	T	T	T
	0.5	T	T	T	T	T
	1	3.3	T	T	T	T
	1.6	1.7	4.1	4.8	T	T
	2	1.4	2.9	3.2	7.6	T

		Selectivity of the 5SL4... for the upstream miniature circuit breaker 5SP4... [kA]				
Miniature Circuit Breakers		5SP4				
Characteristic		C			D	
Rated breaking capacity	I_{cu} [A]	10				
Rated current	I_n [A] ¹⁾	80	100	125	80	100
	3	1.1	2.2	2.4	4.5	7.2
	4	0.9	1.8	2	3.6	5.2
	6	0.8	1.4	1.6	2.8	3.9
	8	0.6	1	1.1	1.8	2.4
	10	0.6	1	1.1	1.8	2.4
	13	0.6	1	1.1	1.8	2.4
	16	0.6	1	1.1	1.8	2.4
	20	0.6	0.9	1	1.6	2.2
	25	0.6	0.9	1	1.6	2.2
	32	0.6	0.9	1	1.7	2.3
	40	--	0.9	--	1.5	2
	50	--	--	--	--	1.5
	63	--	--	--	--	1.5

T \triangleq full selectivity up to I_{cu}/I_{cn} rated short-circuit breaking capacity of the downstream protective device.

¹⁾ In 240/415 V, 50 Hz systems, the selectivity limits are reduced by 10%. The selectivity limits for adjustable releases apply to the maximum value, I_n = rated current. I_r tripping current.

Selectivity limit values of miniature circuit breakers/miniature circuit breakers in kA

		Selectivity of the 5SL4... for the upstream miniature circuit breaker 5SY7... [kA]																	
Miniature Circuit Breakers		5SY7																	
Characteristic		B																	
Rated breaking capacity		10						20						25					
Rated current		I _n [A] ¹⁾																	
		20	25	32	40	50	63	20	25	32	40	50	63	20	25	32	40	50	63
Circuit breaker type: 5SL4...-. Characteristic B I _{cn} [kA] = 10	1	--	--	--	--	T	T	--	--	--	T	--	--	--	0.6	5.7	--	--	--
	2	--	--	--	--	0.5	0.7	--	--	--	0.4	--	--	--	--	--	--	--	--
	3	--	--	--	--	--	0.4	--	--	--	--	--	--	--	--	--	--	--	--
	4	--	--	--	--	--	--	--	--	--	--	--	--	--	--	--	--	--	--
	6	--	--	--	--	--	--	--	--	--	--	--	--	--	--	--	--	--	--
	8	--	--	--	--	--	--	--	--	--	--	--	--	--	--	--	--	--	--
	10	--	--	--	--	--	--	--	--	--	--	--	--	--	--	--	--	--	--
	13	--	--	--	--	--	--	--	--	--	--	--	--	--	--	--	--	--	--
	16	--	--	--	--	--	--	--	--	--	--	--	--	--	--	--	--	--	--
	20	--	--	--	--	--	--	--	--	--	--	--	--	--	--	--	--	--	--
	25	--	--	--	--	--	--	--	--	--	--	--	--	--	--	--	--	--	--
	32	--	--	--	--	--	--	--	--	--	--	--	--	--	--	--	--	--	--
	40	--	--	--	--	--	--	--	--	--	--	--	--	--	--	--	--	--	--
	50	--	--	--	--	--	--	--	--	--	--	--	--	--	--	--	--	--	--
63	--	--	--	--	--	--	--	--	--	--	--	--	--	--	--	--	--	--	
Circuit breaker type: 5SL4...-. Characteristic C I _{cn} [kA] = 10	1	--	--	--	--	T	T	--	--	--	T	--	--	--	0.6	5.7	--	--	--
	2	--	--	--	--	0.5	0.7	--	--	--	0.4	--	--	--	--	--	--	--	--
	3	--	--	--	--	--	0.4	--	--	--	--	--	--	--	--	--	--	--	--
	4	--	--	--	--	--	--	--	--	--	--	--	--	--	--	--	--	--	--
	6	--	--	--	--	--	--	--	--	--	--	--	--	--	--	--	--	--	--
	8	--	--	--	--	--	--	--	--	--	--	--	--	--	--	--	--	--	--
	10	--	--	--	--	--	--	--	--	--	--	--	--	--	--	--	--	--	--
	13	--	--	--	--	--	--	--	--	--	--	--	--	--	--	--	--	--	--
	16	--	--	--	--	--	--	--	--	--	--	--	--	--	--	--	--	--	--
	20	--	--	--	--	--	--	--	--	--	--	--	--	--	--	--	--	--	--
	25	--	--	--	--	--	--	--	--	--	--	--	--	--	--	--	--	--	--
	32	--	--	--	--	--	--	--	--	--	--	--	--	--	--	--	--	--	--
	40	--	--	--	--	--	--	--	--	--	--	--	--	--	--	--	--	--	--
	50	--	--	--	--	--	--	--	--	--	--	--	--	--	--	--	--	--	--
63	--	--	--	--	--	--	--	--	--	--	--	--	--	--	--	--	--	--	
Circuit breaker type: 5SL4...-. Characteristic D I _{cn} [kA] = 10	1	--	--	--	--	T	T	--	--	--	T	--	--	--	0.6	5.7	--	--	--
	2	--	--	--	--	0.5	0.7	--	--	--	0.4	--	--	--	--	--	--	--	--
	3	--	--	--	--	--	0.4	--	--	--	--	--	--	--	--	--	--	--	--
	4	--	--	--	--	--	--	--	--	--	--	--	--	--	--	--	--	--	--
	6	--	--	--	--	--	--	--	--	--	--	--	--	--	--	--	--	--	--
	8	--	--	--	--	--	--	--	--	--	--	--	--	--	--	--	--	--	--
	10	--	--	--	--	--	--	--	--	--	--	--	--	--	--	--	--	--	--

		Selectivity of the 5SL4... for the upstream miniature circuit breaker 5SY7... [kA]																	
Miniature Circuit Breakers		5SY7																	
Characteristic		B																	
Rated breaking capacity	I_{cu} [A]	10						20						25					
Rated current	I_n [A] ¹⁾	20	25	32	40	50	63	20	25	32	40	50	63	20	25	32	40	50	63
	13	--	--	--	--	--	--	--	--	--	--	--	--	--	--	--	--	--	--
	16	--	--	--	--	--	--	--	--	--	--	--	--	--	--	--	--	--	--
	20	--	--	--	--	--	--	--	--	--	--	--	--	--	--	--	--	--	--
	25	--	--	--	--	--	--	--	--	--	--	--	--	--	--	--	--	--	--
	32	--	--	--	--	--	--	--	--	--	--	--	--	--	--	--	--	--	--
	40	--	--	--	--	--	--	--	--	--	--	--	--	--	--	--	--	--	--
	50	--	--	--	--	--	--	--	--	--	--	--	--	--	--	--	--	--	--
	63	--	--	--	--	--	--	--	--	--	--	--	--	--	--	--	--	--	--

T ≙ full selectivity up to I_{cu}/I_{cn} rated short-circuit breaking capacity of the downstream protective device.

1) In 240/415 V, 50 Hz systems, the selectivity limits are reduced by 10%. The selectivity limits for adjustable releases apply to the maximum value, I_n = rated current. I_r tripping current.

Selectivity limit values of miniature circuit breakers/miniature circuit breakers in kA

		Selectivity of the 5SL4... for the upstream miniature circuit breaker 5SY7... [kA]																	
Miniature Circuit Breakers		5SY7																	
Characteristic		C																	
Rated breaking capacity	I _{cu} [A]	10						20						25					
Rated current	I _n [A] ¹⁾	20	25	32	40	50	63	20	25	32	40	50	63	20	25	32	40	50	63
Circuit breaker type: 5SL4...-. Characteristic B I _{cn} [kA] = 10	1	--	--	--	--	--	T	T	--	--	--	--	T	--	--	6	T	T	T
	2	--	--	--	--	--	1.3	2.1	--	--	--	--	1.1	--	--	--	--	0.5	0.5
	3	--	--	--	--	--	0.7	0.9	--	--	--	--	0.6	--	--	--	--	--	--
	4	--	--	--	--	--	0.6	0.7	--	--	--	--	0.5	--	--	--	--	--	--
	6	--	--	--	--	--	0.5	0.6	--	--	--	--	0.4	--	--	--	--	--	--
	8	--	--	--	--	--	0.5	0.6	--	--	--	--	--	--	--	--	--	--	--
	10	--	--	--	--	--	--	0.5	--	--	--	--	--	--	--	--	--	--	--
	13	--	--	--	--	--	0.4	0.5	--	--	--	--	--	--	--	--	--	--	--
	16	--	--	--	--	--	--	0.5	--	--	--	--	--	--	--	--	--	--	--
	20	--	--	--	--	--	--	0.5	--	--	--	--	--	--	--	--	--	--	--
	25	--	--	--	--	--	--	--	--	--	--	--	--	--	--	--	--	--	--
	32	--	--	--	--	--	--	--	--	--	--	--	--	--	--	--	--	--	--
	40	--	--	--	--	--	--	--	--	--	--	--	--	--	--	--	--	--	--
	50	--	--	--	--	--	--	--	--	--	--	--	--	--	--	--	--	--	--
63	--	--	--	--	--	--	--	--	--	--	--	--	--	--	--	--	--	--	
Circuit breaker type: 5SL4...-. Characteristic C I _{cn} [kA] = 10	0.3	--	--	--	--	--	T	T	--	--	--	--	T	--	--	6.6	T	T	T
	0.5	--	--	--	--	--	T	T	--	--	--	--	T	--	--	6.6	T	T	T
	1	--	--	--	--	--	1.7	2.4	--	--	--	--	1.4	--	--	--	--	0.9	1
	1.6	--	--	--	--	--	0.8	1.1	--	--	--	--	0.7	--	--	--	--	0.4	0.4
	2	--	--	--	--	--	0.7	0.8	--	--	--	--	0.6	--	--	--	--	--	--
	3	--	--	--	--	--	0.5	0.7	--	--	--	--	0.4	--	--	--	--	--	--
	4	--	--	--	--	--	0.5	0.6	--	--	--	--	0.4	--	--	--	--	--	--
	6	--	--	--	--	--	--	0.6	--	--	--	--	--	--	--	--	--	--	--
	8	--	--	--	--	--	--	--	--	--	--	--	--	--	--	--	--	--	--
	10	--	--	--	--	--	--	--	--	--	--	--	--	--	--	--	--	--	--
	13	--	--	--	--	--	--	--	--	--	--	--	--	--	--	--	--	--	--
	16	--	--	--	--	--	--	--	--	--	--	--	--	--	--	--	--	--	--
	20	--	--	--	--	--	--	--	--	--	--	--	--	--	--	--	--	--	--
	25	--	--	--	--	--	--	--	--	--	--	--	--	--	--	--	--	--	--
32	--	--	--	--	--	--	--	--	--	--	--	--	--	--	--	--	--	--	
40	--	--	--	--	--	--	--	--	--	--	--	--	--	--	--	--	--	--	
50	--	--	--	--	--	--	--	--	--	--	--	--	--	--	--	--	--	--	
63	--	--	--	--	--	--	--	--	--	--	--	--	--	--	--	--	--	--	
Circuit breaker type: 5SL4...-. Characteristic D	0.3	--	--	--	--	--	T	T	--	--	--	--	T	--	--	7.4	T	T	T
	0.5	--	--	--	--	--	T	T	--	--	--	--	T	--	--	7.4	T	T	T
	1	--	--	--	--	--	1	1.3	--	--	--	--	0.8	--	--	--	--	0.5	0.5
	1.6	--	--	--	--	--	0.8	0.9	--	--	--	--	0.7	--	--	--	--	--	--

		Selectivity of the 5SL4... for the upstream miniature circuit breaker 5SY7... [kA]																	
Miniature Circuit Breakers		5SY7																	
Characteristic		C																	
Rated breaking capacity	I_{cu} [A]	10						20						25					
Rated current	I_n [A] ¹⁾	20	25	32	40	50	63	20	25	32	40	50	63	20	25	32	40	50	63
I_{cn} [kA] = 10	2	--	--	--	--	--	0.6	0.7	--	--	--	--	0.5	--	--	--	--	--	--
	3	--	--	--	--	--	0.5	0.6	--	--	--	--	0.4	--	--	--	--	--	--
	4	--	--	--	--	--	--	0.6	--	--	--	--	--	--	--	--	--	--	--
	6	--	--	--	--	--	0.4	0.5	--	--	--	--	--	--	--	--	--	--	--
	8	--	--	--	--	--	--	--	--	--	--	--	--	--	--	--	--	--	--
	10	--	--	--	--	--	--	--	--	--	--	--	--	--	--	--	--	--	--
	13	--	--	--	--	--	--	--	--	--	--	--	--	--	--	--	--	--	--
	16	--	--	--	--	--	--	--	--	--	--	--	--	--	--	--	--	--	--
	20	--	--	--	--	--	--	--	--	--	--	--	--	--	--	--	--	--	--
	25	--	--	--	--	--	--	--	--	--	--	--	--	--	--	--	--	--	--
	32	--	--	--	--	--	--	--	--	--	--	--	--	--	--	--	--	--	--
	40	--	--	--	--	--	--	--	--	--	--	--	--	--	--	--	--	--	--
	50	--	--	--	--	--	--	--	--	--	--	--	--	--	--	--	--	--	--
63	--	--	--	--	--	--	--	--	--	--	--	--	--	--	--	--	--	--	

T ≙ full selectivity up to I_{cu}/I_{cn} rated short-circuit breaking capacity of the downstream protective device.

¹⁾ In 240/415 V, 50 Hz systems, the selectivity limits are reduced by 10%. The selectivity limits for adjustable releases apply to the maximum value, I_n = rated current. I_r tripping current.

Selectivity limit values of miniature circuit breakers/miniature circuit breakers in kA

		Selectivity of the 5SL4... for the upstream miniature circuit breaker 5SY7... [kA]																	
Miniature Circuit Breakers		5SY7																	
Characteristic		D																	
Rated breaking capacity		10						20						25					
Rated current		I _n [A] ¹⁾																	
		20	25	32	40	50	63	20	25	32	40	50	63	20	25	32	40	50	63
Circuit breaker type: 5SL4...-. Characteristic B I _{cn} [kA] = 10	1	--	--	--	--	--	T	T	--	--	--	--	T	--	--	T	T	T	T
	2	--	--	--	--	--	T	T	--	--	--	--	T	--	--	0.8	1	1.3	3.2
	3	--	--	--	--	--	3.8	8.9	--	--	--	--	2.1	--	--	0.5	0.5	0.7	1.1
	4	--	--	--	--	--	1.8	2.4	--	--	--	--	1.3	--	--	--	0.4	0.6	0.8
	6	--	--	--	--	--	1.4	1.9	--	--	--	--	1.1	--	--	--	0.4	0.5	0.7
	8	--	--	--	--	--	1.3	1.6	--	--	--	--	1	--	--	--	--	0.5	0.7
	10	--	--	--	--	--	1.2	1.4	--	--	--	--	0.9	--	--	--	--	0.4	0.6
	13	--	--	--	--	--	1.1	1.3	--	--	--	--	0.9	--	--	--	--	0.4	0.6
	16	--	--	--	--	--	1	1.2	--	--	--	--	0.8	--	--	--	--	--	0.6
	20	--	--	--	--	--	1	1.2	--	--	--	--	0.8	--	--	--	--	--	0.5
	25	--	--	--	--	--	0.9	1.1	--	--	--	--	0.7	--	--	--	--	--	0.5
	32	--	--	--	--	--	0.8	1	--	--	--	--	0.7	--	--	--	--	--	--
	40	--	--	--	--	--	0.8	1	--	--	--	--	--	--	--	--	--	--	--
	50	--	--	--	--	--	--	1	--	--	--	--	--	--	--	--	--	--	--
63	--	--	--	--	--	--	--	--	--	--	--	--	--	--	--	--	--	--	
Circuit breaker type: 5SL4...-. Characteristic C I _{cn} [kA] = 10	0.3	--	--	--	--	--	T	T	--	--	--	--	T	--	--	T	T	T	T
	0.5	--	--	--	--	--	T	T	--	--	--	--	T	--	--	T	T	T	T
	1	--	--	--	--	--	T	T	--	--	--	--	T	--	--	1.2	1.3	1.7	3.7
	1.6	--	--	--	--	--	6.4	T	--	--	--	--	3	--	--	0.6	0.6	0.8	1.4
	2	--	--	--	--	--	2.4	3.2	--	--	--	--	1.5	--	--	0.4	0.5	0.7	0.9
	3	--	--	--	--	--	1.7	2.3	--	--	--	--	1.2	--	--	--	0.4	0.5	0.8
	4	--	--	--	--	--	1.4	2	--	--	--	--	1.1	--	--	--	0.4	0.5	0.7
	6	--	--	--	--	--	1.2	1.5	--	--	--	--	0.9	--	--	--	--	0.4	0.6
	8	--	--	--	--	--	0.9	1.1	--	--	--	--	0.7	--	--	--	--	--	0.5
	10	--	--	--	--	--	0.9	1.1	--	--	--	--	0.7	--	--	--	--	--	0.5
	13	--	--	--	--	--	0.9	1.1	--	--	--	--	0.7	--	--	--	--	--	0.5
	16	--	--	--	--	--	0.9	1.1	--	--	--	--	0.7	--	--	--	--	--	0.5
	20	--	--	--	--	--	0.9	1	--	--	--	--	0.7	--	--	--	--	--	0.5
	25	--	--	--	--	--	0.9	1	--	--	--	--	0.7	--	--	--	--	--	0.5
32	--	--	--	--	--	0.8	1	--	--	--	--	0.6	--	--	--	--	--	--	
40	--	--	--	--	--	0.8	0.9	--	--	--	--	--	--	--	--	--	--	--	
50	--	--	--	--	--	--	0.9	--	--	--	--	--	--	--	--	--	--	--	
63	--	--	--	--	--	--	--	--	--	--	--	--	--	--	--	--	--	--	
Circuit breaker type: 5SL4...-. Characteristic D	0.3	--	--	--	--	--	T	T	--	--	--	--	T	--	--	T	T	T	T
	0.5	--	--	--	--	--	T	T	--	--	--	--	T	--	--	T	T	T	T
	1	--	--	--	--	--	8.7	T	--	--	--	--	2.9	--	--	0.6	0.7	1	1.6
	1.6	--	--	--	--	--	2.6	3.7	--	--	--	--	1.6	--	--	0.5	0.6	0.8	1.1

		Selectivity of the 5SL4... for the upstream miniature circuit breaker 5SY7... [kA]																	
Miniature Circuit Breakers		5SY7																	
Characteristic		D																	
Rated breaking capacity	I_{cu} [A]	10						20						25					
Rated current	I_n [A] ¹⁾	20	25	32	40	50	63	20	25	32	40	50	63	20	25	32	40	50	63
I_{cn} [kA] = 10	2	--	--	--	--	--	2.1	2.7	--	--	--	--	1.4	--	--	0.4	0.5	0.6	0.9
	3	--	--	--	--	--	1.5	2	--	--	--	--	1.1	--	--	--	0.4	0.5	0.8
	4	--	--	--	--	--	1.3	1.7	--	--	--	--	0.9	--	--	--	--	--	0.7
	6	--	--	--	--	--	1.1	1.4	--	--	--	--	0.8	--	--	--	--	--	0.6
	8	--	--	--	--	--	0.8	1	--	--	--	--	0.7	--	--	--	--	--	0.5
	10	--	--	--	--	--	0.8	1	--	--	--	--	0.7	--	--	--	--	--	0.5
	13	--	--	--	--	--	0.8	1	--	--	--	--	0.7	--	--	--	--	--	0.5
	16	--	--	--	--	--	0.8	1	--	--	--	--	0.7	--	--	--	--	--	0.5
	20	--	--	--	--	--	0.8	0.9	--	--	--	--	0.6	--	--	--	--	--	0.5
	25	--	--	--	--	--	0.8	0.9	--	--	--	--	0.6	--	--	--	--	--	0.5
	32	--	--	--	--	--	0.8	0.9	--	--	--	--	--	--	--	--	--	--	--
	40	--	--	--	--	--	--	0.9	--	--	--	--	--	--	--	--	--	--	--
	50	--	--	--	--	--	--	--	--	--	--	--	--	--	--	--	--	--	--
63	--	--	--	--	--	--	--	--	--	--	--	--	--	--	--	--	--	--	

T ≙ full selectivity up to I_{cu}/I_{cn} rated short-circuit breaking capacity of the downstream protective device.

¹⁾ In 240/415 V, 50 Hz systems, the selectivity limits are reduced by 10%. The selectivity limits for adjustable releases apply to the maximum value, I_n = rated current. I_i r tripping current.

Selectivity limit values of miniature circuit breakers/miniature circuit breakers in kA

		Selectivity of the 5SL6... for the upstream miniature circuit breaker 5SP4... [kA]					
Miniature Circuit Breakers		5SP4					
Characteristic		C			D		
Rated breaking capacity		I _{cu} [A] 10					
Rated current		I _n [A] ¹⁾	80	100	125	80	100
Circuit breaker type: 5SL6...-. (without 5SL60) Characteristic B I _{cn} [kA] = 6	6	1	1.3	1.4	2	3	
	10	1	1.2	1.3	2	2.7	
	13	1	1.2	1.3	2	2.7	
	16	1	1	1.1	2	2.3	
	20	1	1	1.1	2	2.3	
	25	1	1	1.1	2	2.2	
	32	1	1	1.1	2	2.1	
	40	1	1.1	1.1	2	2.3	
	50	1	1	1	2	2	
	63	--	0.9	1	1	1.9	
Circuit breaker type: 5SL6...-. (without 5SL60) Characteristic C I _{cn} [kA] = 6	0.5	T	T	T	T	T	
	1	T	T	T	T	T	
	1.6	1	3.5	4.4	T	T	
	2	1	2.2	2.4	4	T	
	3	1	1.8	2	2	4.9	
	4	1	1.7	1.9	3	4.7	
	6	1	1.7	1.9	3	4.7	
	8	1	1.2	1.3	2	2.8	
	10	1	1.2	1.3	2	2.7	
	13	1	1.2	1.3	2	2.7	
	16	1	1	1.1	2	2.3	
	20	1	1	1.1	2	2.3	
	25	1	1	1.1	2	2.2	
	32	1	1	1.1	2	2.1	
	40	1	1.1	1.1	2	2.3	
50	1	1	1	2	2		
63	--	0.9	1	1	1.9		

T ≙ full selectivity up to I_{cu}/I_{cn} rated short-circuit breaking capacity of the downstream protective device.

¹⁾ In 240/415 V, 50 Hz systems, the selectivity limits are reduced by 10%. The selectivity limits for adjustable releases apply to the maximum value, I_n = rated current. I_r r tripping current.

Selectivity limit values of miniature circuit breakers/miniature circuit breakers in kA

		Selectivity of the 5SL6... for the upstream miniature circuit breaker 5SY7... [kA]													
Miniature Circuit Breakers		5SY7													
Characteristic		B							C						
Rated breaking capacity	I_{cu} [A]	15			20	25			15			20	25		
		50	63	40	16	20	25	32	50	63	40	16	20	25	32
Rated current	I_n [A] ¹⁾	50	63	40	16	20	25	32	50	63	40	16	20	25	32
Circuit breaker type: 5SL6...-. (without 5SL60) Characteristic B I_{cn} [kA] = 6	6	0.2	0.3	0.2	--	0.1	0.1	0.1	0.4	0.5	0.3	0.1	0.2	0.2	0.2
	10	0.2	0.3	0.2	--	0.1	0.1	0.1	0.4	0.5	0.3	0.1	0.2	0.2	0.2
	13	--	0.3	--	--	--	--	--	0.4	0.5	0.3	--	--	--	--
	16	--	--	--	--	--	--	--	0.4	0.4	0.3	--	--	--	--
	20	--	--	--	--	--	--	--	0.4	0.4	0.3	--	--	--	--
	25	--	--	--	--	--	--	--	0.4	0.4	0.3	--	--	--	--
	32	--	--	--	--	--	--	--	0.4	0.4	0.3	--	--	--	--
	40	--	--	--	--	--	--	--	--	--	--	--	--	--	--
	50	--	--	--	--	--	--	--	--	--	--	--	--	--	--
Circuit breaker type: 5SL6...-. (without 5SL60) Characteristic C I_{cn} [kA] = 6	0.5	1.8	2.4	1.3	0.2	0.4	0.5	0.8	T	T	4	0.7	1.1	1.5	1.6
	1	0.8	0.9	0.6	0.1	0.2	0.3	0.4	1.3	2.2	1.1	0.4	0.5	0.7	0.7
	1.6	0.4	0.4	0.3	0.1	0.1	0.2	0.2	0.7	0.9	0.6	0.2	0.3	0.4	0.4
	2	0.3	0.4	0.3	0.1	0.1	0.1	0.2	0.6	0.8	0.5	0.2	0.2	0.3	0.3
	3	0.3	0.3	0.2	--	0.1	0.1	0.2	0.5	0.7	0.4	0.2	0.2	0.3	0.3
	4	0.3	0.3	0.2	--	0.1	0.1	0.2	0.5	0.7	0.4	0.2	0.2	0.3	0.3
	6	0.3	0.3	0.2	--	0.1	0.1	0.2	0.5	0.7	0.4	0.2	0.2	0.3	0.3
	8	0.2	0.3	0.2	--	0.1	0.1	0.1	0.4	0.5	0.3	0.1	0.2	0.2	0.2
	10	0.2	0.3	0.2	--	0.1	0.1	0.1	0.4	0.5	0.3	0.1	0.2	0.2	0.2
	13	--	0.3	--	--	--	--	--	0.4	0.5	0.3	--	--	--	--
	16	--	--	--	--	--	--	--	0.4	0.4	0.3	--	--	--	--
	20	--	--	--	--	--	--	--	0.4	0.4	0.3	--	--	--	--
	25	--	--	--	--	--	--	--	0.4	0.4	0.3	--	--	--	--
	32	--	--	--	--	--	--	--	0.4	0.4	0.3	--	--	--	--
	40	--	--	--	--	--	--	--	--	--	--	--	--	--	--
50	--	--	--	--	--	--	--	--	--	--	--	--	--	--	
63	--	--	--	--	--	--	--	--	--	--	--	--	--	--	

T ≙ full selectivity up to I_{cu}/I_{cn} rated short-circuit breaking capacity of the downstream protective device.

1) In 240/415 V, 50 Hz systems, the selectivity limits are reduced by 10%. The selectivity limits for adjustable releases apply to the maximum value, I_n = rated current. I_{lr} tripping current.

9.3 Selectivity

		Selectivity of the 5SL6... for the upstream miniature circuit breaker 5SY7... [kA]						
Miniature Circuit Breakers		5SY7						
Characteristic		D						
Rated breaking capacity	I_{cu} [A]	15		20	25			
Rated current	I_n [A] ¹⁾	50	63	40	16	20	25	32
Circuit breaker type: 5SL6...- (without 5SL60) Characteristic B I_{cn} [kA] = 6	6	1.1	1.3	0.9	0.3	0.3	0.4	0.6
	10	1	1.2	0.8	0.3	0.3	0.4	0.6
	13	1	1.2	0.8	0.3	0.3	0.4	0.5
	16	0.9	1	0.7	--	0.3	0.4	0.5
	20	0.9	1	0.7	--	--	0.3	0.5
	25	0.9	1	0.7	--	--	--	0.5
	32	0.9	1.1	0.7	--	--	--	--
	40	0.9	1.1	--	--	--	--	--
	50	--	1	--	--	--	--	--
	63	--	--	--	--	--	--	--
Circuit breaker type: 5SL6...- (without 5SL60) Characteristic C I_{cn} [kA] = 6	0.5	T	T	T	2.7	3.1	T	T
	1	T	T	T	0.9	1	1.3	2.9
	1.6	2.3	3.3	1.5	0.5	0.5	0.7	1
	2	1.6	2.1	1.2	0.4	0.4	0.6	0.9
	3	1.4	1.8	1.1	0.4	0.4	0.5	0.8
	4	1.3	1.7	1.1	0.4	0.4	0.5	0.8
	6	1.3	1.7	1.1	0.4	0.4	0.5	0.8
	8	1	1.2	0.8	0.3	0.3	0.4	0.6
	10	1	1.2	0.8	0.3	0.3	0.4	0.6
	13	1	1.2	0.8	0.3	0.3	0.4	0.5
	16	0.9	1	0.7	--	0.3	0.4	0.5
	20	0.9	1	0.7	--	--	0.3	0.5
	25	0.9	1	0.7	--	--	--	0.5
	32	0.9	1.1	0.7	--	--	--	--
	40	0.9	1.1	--	--	--	--	--
50	--	1	--	--	--	--	--	
63	--	--	--	--	--	--	--	

T ≙ full selectivity up to I_{cu}/I_{cn} rated short-circuit breaking capacity of the downstream protective device.

¹⁾ In 240/415 V, 50 Hz systems, the selectivity limits are reduced by 10%. The selectivity limits for adjustable releases apply to the maximum value, I_n = rated current. I_r tripping current.

9.3.3 Selectivity of miniature circuit breakers/circuit breakers

More information

Technical specifications are available on the internet
(<https://support.industry.siemens.com/cs/ww/en/view/109748621>)

9.3.4 Selectivity of miniature circuit breakers/molded case circuit breakers

More information

Technical specifications are available on the internet
(<https://support.industry.siemens.com/cs/ww/en/view/109748621>)

9.4 Back-up protection

9.4.1 Back-up protection of miniature circuit breakers/fuses

If the maximum short-circuit current of the miniature circuit breaker at the installation location is unknown, or if the specified rated switching capacity is exceeded, an additional protective device must be connected upstream as back-up protection to prevent overloading of the miniature circuit breaker. Fuses or, in fuseless distribution boards, molded case circuit breakers or more powerful miniature circuit breakers are generally used for this purpose. The back-up protection tables show the short-circuit currents – in kA – up to which back-up protection is guaranteed.

Technical specifications on limit values for back-up protection of miniature circuit breakers/fuses in kA are available on the internet (<https://support.industry.siemens.com/cs/ww/en/view/109795875>).

The term "combined short-circuit protection" has been introduced with the publication of DIN VDE 0100-530:2018-06. Combined short-circuit protection describes the coordination of two overcurrent protective devices (e.g. miniature circuit breaker/circuit breaker or fuse) with regard to short-circuit breaking capacity. Overcurrent can be caused by overload or short-circuit. The term "back-up protection" in connection with the coordination of overcurrent protective devices such as miniature circuit breakers/circuit breakers or fuses is therefore increasingly being replaced by the term "combined short-circuit protection".

Back-up protection limit values of miniature circuit breakers/fuses in kA

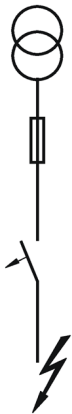
	Downstream miniature circuit breakers	Upstream fuse, operational class gG						
	I_n [A] ¹⁾	50 A	63 A	80 A	100 A	125 A	160 A	>160 A
	5SY6							
	0.3 ... 4	No back-up protection required ¹⁾						
	6	50	50	50	50	50	35	30
	8	50	50	50	50	50	35	15
	10	50	50	50	50	50	35	15
	13	50	50	50	35	35	30	15
	16	50	50	50	35	30	30	15
	20	50	50	50	35	25	25	15
	25	50	50	50	35	30	25	15
	32	50	50	50	35	30	25	15
	40	50	50	50	50	25	15	10
	50	50	50	50	50	25	15	10
	63	50	50	35	25	25	15	10
	5SY4, 5SY7, 5SY8, 5SJ4...-HG..²⁾							
	0.3 ... 4	No back-up protection required ¹⁾						
	8	50	50	50	50	45	45	40
	10	50	50	50	50	45	45	40
	13	50	50	50	45	40	35	30
	16	50	50	50	45	40	35	30
	20	50	50	50	40	35	30	30
	25	50	50	50	40	35	30	30
	32	50	50	50	45	40	30	30
	40	50	50	50	45	40	30	20
	50	50	50	50	40	35	25	20
	63	50	50	45	40	35	25	20
	Test circuit data: $U_p = 250$ V $\cos \varphi = 0.3 \dots 0.5$	Test cycle: Acc. to EN 60947-2 (0 - C0)						

¹⁾ Up to the respective I_{cu} according to the table "Rated switching capacity" in section Switching capacity (Page 81).

²⁾ The values specified for 5SJ4...-HG.. are not according to UL but are the manufacturer's specifications according to EN 60947-2 and apply for voltage $U_e = 230$ V ~. For available rated currents, see Catalog LV10.

Back-up protection limit values of miniature circuit breakers/fuses in kA

Fuse		Upstream fuses 3NA..., 5SB4..., 5SE2... [kA]					
		3NA		5SB4		5SE2	
Operational class		gG		gG		gG	
Size		2		DIII		D02	
Rated breaking capacity	I_{cu} [AC kA]	120		50		50	
Rated voltage	U_b [AC V]	500		500		400	
Rated current	I_n [A] ¹⁾	50	63	50	63	50	63
Circuit breaker type: 5SL4...-. Characteristic B I_{cn} [kA] = 10	1	50	50	50	50	50	50
	2	50	50	50	50	50	50
	3	50	50	50	50	50	50
	4	50	50	50	50	50	50
	6	50	50	50	50	50	50
	8	50	50	50	50	50	50
	10	50	50	50	50	50	50
	13	50	50	50	50	50	50
	16	50	50	50	50	50	50
	20	50	50	50	50	50	50
	25	50	50	50	50	50	50
	32	50	50	50	50	50	50
	40	--	50	--	50	--	50
Circuit breaker type: 5SL4...-. Characteristic C/D I_{cn} [kA] = 10	0.3	50	50	50	50	50	50
	0.5	50	50	50	50	50	50
	1	50	50	50	50	50	50
	1.6	50	50	50	50	50	50
	2	50	50	50	50	50	50
	3	50	50	50	50	50	50
	4	50	50	50	50	50	50
	6	50	50	50	50	50	50
	8	50	50	50	50	50	50
	10	50	50	50	50	50	50
	13	50	50	50	50	50	50
	16	50	50	50	50	50	50
	20	50	50	50	50	50	50
25	50	50	50	50	50	50	
32	50	50	50	50	50	50	
40	--	50	--	50	--	50	

Back-up protection limit values of miniature circuit breakers/fuses in kA

		Upstream fuses 3NA.... [kA]			
Fuse		3NA			
Operational class		gG			
Size		2			
Rated breaking capacity	I_{cu} [AC kA]	120			
Rated voltage	U_b [AC V]	500			
Rated current	I_n [A] ¹⁾	63	80	100	125
Circuit breaker type: 5SL6...-. (without 5SL60) Characteristic B I_{cn} [kA] = 6	6	6	6	6	6
	10	6	6	6	6
	13	6	6	6	6
	16	6	6	6	6
	20	6	6	6	6
	25	6	6	6	6
	32	6	6	6	6
Circuit breaker type: 5SL6...-. (without 5SL60) Characteristic C I_{cn} [kA] = 6	0.3	6	6	6	6
	0.5	6	6	6	6
	1	6	6	6	6
	1.6	6	6	6	6
	2	6	6	6	6
	3	6	6	6	6
	4	6	6	6	6
	6	6	6	6	6
	8	6	6	6	6
	10	6	6	6	6
	13	6	6	6	6
	16	6	6	6	6
	20	6	6	6	6
	25	6	6	6	6
32	6	6	6	6	

9.4.2 Back-up protection of miniature circuit breakers/molded case circuit breakers

Technical specifications for back-up protection limit values of miniature circuit breakers/molded case circuit breakers in kA are available on the internet (<https://support.industry.siemens.com/cs/ww/en/view/109795875>).

5SJ4...-HG miniature circuit breakers acc. to UL 489 and IEC, and accessories

10

10.1 Overview

UL standards are used in North America as well as in several other countries. This is of particular importance to European exporters of electrical switchgear assemblies and equipment for machines who export to the USA, as their products will only be accepted if they meet the relevant UL standards.

A wide range of low-voltage circuit protection devices from Siemens comply with UL standards and are therefore suitable for implementation worldwide in both IEC/EN and UL applications within the framework of their specified use.

Miniature circuit breakers certified to UL 489 permit use as an all-round solution for protection tasks in distribution boards, control cabinets and control systems to UL 508A as "branch protectors". In particular, they are also approved for the protection of electrical circuits in heating, ventilating and cooling systems (HVAC), as well as for DC applications up to 60 V/125 V.

This covers a wide range of protection tasks, in residential and non-residential buildings, as well as in industry. The tripping characteristics B, C and D to EN/IEC 60898-1 have been adapted so that they fall in the permissible tripping range according to UL 489, as well as for applications at 25 °C and 40 °C.

This means that the devices are approved for use according to both standards. The overall dimensions of the devices correspond to DIN format. This means that the device series are suitable for universal use worldwide according to IEC or UL standards.

The key difference between the three device series is their application in different power supply systems.

- 5SJ4...-HG40: 240/120 V AC, 1-pole, "same polarity only",
- 5SJ4...-HG41: 240 V AC, 1-, 2- and 3-pole,
- 5SJ4...-HG42: 480Y/277 V AC, 1-, 2- and 3-pole.

The connection terminals are suitable for "field wiring". This means that the devices can be installed not only in factory-built distribution boards and control cabinets, but also on-site in a customer system.

Using this mounting concept, all 5ST3...-HG additional components can be combined with miniature circuit breakers of the 5SJ4...-HG range. The auxiliary switch (AS) signals the contact position. In the event of a fault, the fault signal contact (FC) signals the automatic tripping of the MCB as well as the contact position. Shunt trips (ST) are used for the remote tripping of miniature circuit breakers. Captive metal brackets on the additional components ensure fast mounting on the devices.

1-, 2- and 3-phase busbars in 3 lengths with 6, 12 or 18 pins are available as accessories for all device series for "field wiring". The infeed is via connection terminals, which are available in two versions, for direct infeed at either the busbar or the miniature circuit breakers. Pins that are not required can be covered with touch protection covers.

10.2 Technical specifications

		Miniature Circuit Breakers			
		Unit	5SJ4...-HG40	5SJ4...-HG41	5SJ4...-HG42
Standards		EN 60947-2 UL 489 (UL File E243414); UL 489A (UL File E332105); CSA C22.2 No. 5-02			
Approvals		see internet (www.siemens.com/lowvoltage/certificates)			
Tripping characteristic		B, C, D		C, D	
Rated voltage					
<ul style="list-style-type: none"> Acc. to EN 60947-2 Acc. to UL 489 and CSA C22.2 No. 5-02 	V AC	230 / 400	230 / 400	230 / 400	
	V AC	240 / 120	240	480 / 277	
	V DC / 1P	60	60	60	
	V DC / 2P		125	125	
Operational voltage					
	Min.	V AC/DC per pole	24		
<ul style="list-style-type: none"> Acc. to IEC 60947-2 	Max.	V DC per pole	60		
	Max.	V AC	250 / 440		
<ul style="list-style-type: none"> Acc. to UL 489 	Max.	V DC per pole	60		
Rated breaking capacity					
<ul style="list-style-type: none"> I_{cu} acc. to IEC 60947-2 	kA AC	15			
<ul style="list-style-type: none"> Acc. to UL 489/UL 489A and CSA C22.2 No. 5-02 	kA AC	14 / 10 ¹⁾	14 / 10 ¹⁾	14 / 10 ¹⁾	
Insulation coordination					
<ul style="list-style-type: none"> Rated insulation voltage 	V AC	250	250 / 440		
<ul style="list-style-type: none"> Pollution degree for overvoltage category 	3 / III				
Rated frequency	Hz	50 / 60			
Touch protection acc. to EN 50274		Yes			
Handle end position, sealable		Yes			
Degree of protection acc. to EN 60529		IP40 in the area of the handle			
CFC and silicone-free		Yes			
Mounting		On DIN rail			
Terminals	± screw (Poqidriv)	2			
Combined terminals at both ends		Yes			
Terminal tightening torque	Nm	3.5			
	lb/in	31			
Conductor cross-sections					
<ul style="list-style-type: none"> Solid and stranded, acc. to UL 489 and CSA C22.2 No. 5-02 	AWG	18 ... 4			
<ul style="list-style-type: none"> AWG cables (Cu 60/75 °C $I_n \leq 40$ A; 60 °C $I_n > 40$ A) 					

Miniature Circuit Breakers		
• Solid and stranded, acc. to IEC 60898-1	mm ²	0.75 ... 25
• Finely stranded, with end sleeve	mm ²	0.75 ... 25
Mains connection		Any
Mounting position		Any
Vertical device clearance with DIN rails mounted one above the other (grid distance acc. to IEC/EN 60898-1) ²⁾	mm	35
Service life/endurance, on average, with rated load		20000 actuations
EMC environment		
• Acc. to EN 60947-2		Suitable for environment "B" (immunity to interference not applicable)
Ambient temperature	°C	-25 ... +55, max. 95 % humidity
Storage temperature	°C	-40 ... +75
Resistance to climate Acc. to IEC 60068-2-30		6 cycles
Resistance to vibrations Acc. to IEC 60068-2-6	m/s ²	50 at 25 ... 150 Hz and 60 at 35 Hz (4 sec)

¹⁾ For detailed information on rated switching capacity, see More information (Page 164)

²⁾ For more explanations and application notes, see Consideration of minimum clearances (Page 99)

10.3 Conductor cross-sections

In accordance with the device approvals according to UL489 (Ed.13:2016), UL489A (Ed.1:2008) and EN60947-2:2013 / IEC660947-2:2016, conductors can be connected as shown in the following table for the miniature circuit breakers 5SJ4...-HG4.

Number of connected conductors		Solid ($\leq 10 \text{ mm}^2$) / stranded ($\geq 16 \text{ mm}^2$)	Finely stranded with insulated end sleeve		Finely stranded without end sleeve ²⁾	
1 conductor at front	mm ²	0.75 ... 25	0.75 ... 25		1 ... 25	
1 conductor at rear (+ busbar ¹⁾ rear)	mm ²	0.75 ... 16	0.75 ... 10		1 ... 16	
1 conductor at front + 1 conductor at rear	mm ²	f: 0.75 ... 25 r: 0.75 ... 16	f: 0.75 ... 16 f: 0.75 ... 6	f: 25 r: 0.75 ... 4	f: 1 ... 16 r: 1 ... 16	f: 25 r: 1 ... 6

1) When bus mounting with pin busbars according to UL489 5ST36...HG, 5ST37...HG, the busbars are connected only in the front terminal area.

2) The general installation regulations must be observed; finely stranded conductors must be twisted before being inserted into the terminal; no individual copper fibers are allowed to project after connecting to the terminal.

	Unit	Auxiliary switches (AS)		Fault signal contacts (FC)		Shunt trips (ST)		
		5ST3010-0HG 5ST3011-0HG 5ST3011-0HG		5ST3020-0HG 5ST3021-0HG 5ST3021-0HG		5ST3030-0HG	5ST3031-0HG	
Standards		UL 489, UL File E321559; CSA 22.2 No. 5-02						
		IEC/EN 62019, IEC/EN 60947-5-1				IEC/EN 60947-1		
Operational voltage/operational current (load)								
• Acc. to IEC	V AC	400	230			110 ... 415	24 ... 60	
	A AC	2	6 (NC: 13 AC, NO: AC14)				--	--
	V AC	220	110	60	24	--	24 ... 60	
	A AC	1	1	3	6 (DC13)	--	--	
• Acc. to UL	V AC	480	277	240	120	110 ... 415	24 ... 60	
	A AC	1.5	3	6	6	--	--	
	V DC	125	60			--	24 ... 60	
	A DC	1	3			--	--	
Rated frequency	Hz	50 / 60						
Short-circuit protection		Miniature circuit breaker or 6 A fuse						
Minimum contact load		50 mA, 24 V						
Tripping operations		--		--		Max. 2000		
Service life/endurance, on average, with rated load		12000 actuations						
Operating range	x U_n	--				0.7 ... 1.1		
Conductor cross-sections	AWG	22 ... 14				22 ... 14		
	mm ²	0.5 ... 2.5				0.5 ... 2.5		

	Unit	Auxiliary switches (AS)	Fault signal contacts (FC)	Shunt trips (ST)
Terminals	± screw (Pozidriv)	1	1	1
Terminal tightening torque	Nm	0.5		0.8
	lb/in	4.5		6.8

	Unit	Busbars	Busbars, can be cut	Connection terminals		
		5ST3663-.HG ¹⁾ 5ST3664-.HG ¹⁾ 5ST3665-.HG ¹⁾	5ST3701-3HG 5ST3703-3HG 5ST3705-3HG 5ST3707-3HG 5ST3710-3HG 5ST3712-3HG 5ST3714-3HG	5ST3666-0HG ¹⁾	5ST3666-2HG ¹⁾	5ST3770-3HG
Standards		UL 489				
		UL File No. E321559	UL File No. E315616	UL File No. E321559		UL File No. E315616
Operational voltage						
• Acc. to IEC	V AC	1000/1-pole		600/2- to 3-pole		
• Acc. to UL 489	V AC	1000/1-pole		600/2- to 3-pole (60 Hz)		
Rated conditional short-circuit current	kA	10 kA at 600 V	10 kA at 600 V with J 175 A fuse	10 kA at 600 V		10 kA at 600 V with J 175 A fuse
Dielectric strength	kV/m m	35				
Impulse withstand voltage	kV	> 9.5	> 10	> 9.5		> 10
Rated current	A	115 at 40 °C ambient temperature	80 (infeed end) 160 (infeed center) at 35 °C ambient temperature	115 (Cu 75 °C) 95 (Cu 60 °C) at 40 °C ambient temperature	115 (Cu 75 °C) 110 (Cu 60 °C) at 40 °C ambient temperature	115 (Cu 75 °C) 95 (Cu 60 °C) at 35 °C ambient temperature
Insulation coordination						
• Pollution degree		2				
• Overvoltage category		III				
Busbar cross-section (Cu)	mm ²	16	18	16		18
Infeed		Any				
Conductor cross-sections						
• AWG cables	AWG	--		14 ... 2	14 ... 1	14 ... 2
• Solid and stranded	mm ²	--		2.5 ... 35	2.5 ... 50	2.5 ... 35

10.3 Conductor cross-sections

	Unit	Busbars	Busbars, can be cut	Connection terminals		
Terminals		--		6 mm Allen key	± screw (Pozidriv) 2	6 mm Allen key
Terminal tightening torque	Nm	--		5.5	4	5.5
	lb/in	--		50	35	50
Temperature resistance	°C	125 – UL 94-V0/0.4 mm				
Interrupting rating		10 kA at 600 V AC/DC				

Note

1) The busbars and connection terminals are suitable for applications up to 80 A if installed in distribution boards with min. dimensions of 18 x 18 x 6.25 inches, or up to 115 A if installed in distribution boards with min. dimensions of 30 x 30 x 10 inches.

Tripping characteristics acc. to IEC/EN 60898-1 and UL 489/CSA 22.2 No. 5-02 for AC

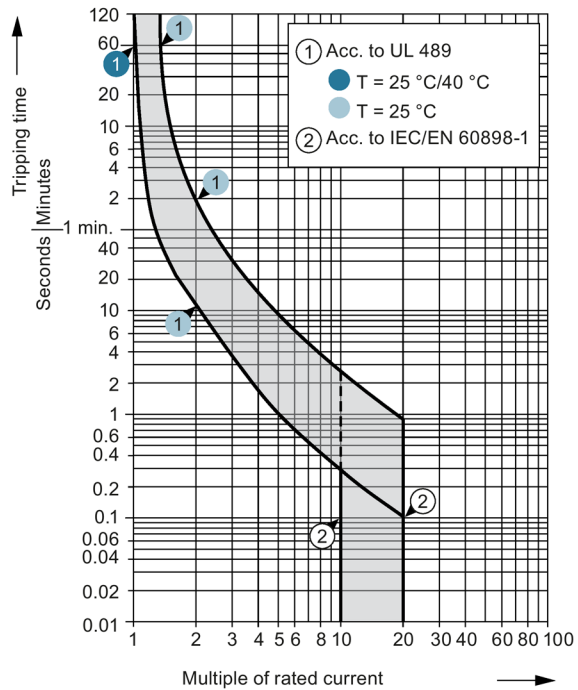
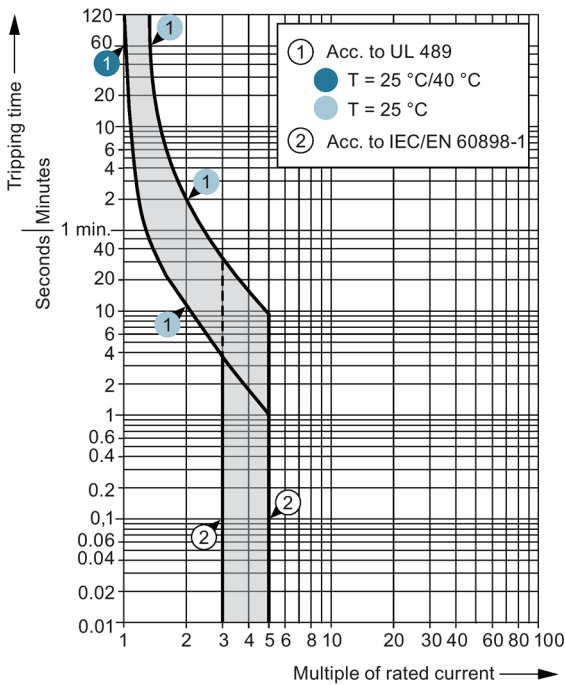

Tripping characteristic B

MCBs with this tripping characteristic are designed for universal use in socket outlet and lighting circuits. Proof of personal safety acc. to DIN VDE 0100-410 is not required.

Tripping characteristic D

For electrical circuits with strong pulse-generating equipment, such as transformers or solenoid valves.

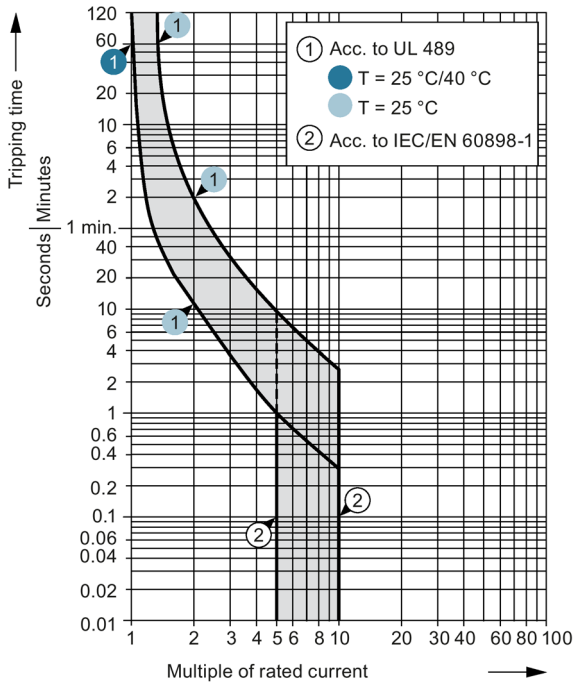

Tripping characteristic C

Primarily used in lamp and motor circuits with higher starting currents.

Correction factors for rated current at different ambient temperatures

Dependence of the permissible continuous load on ambient temperature.

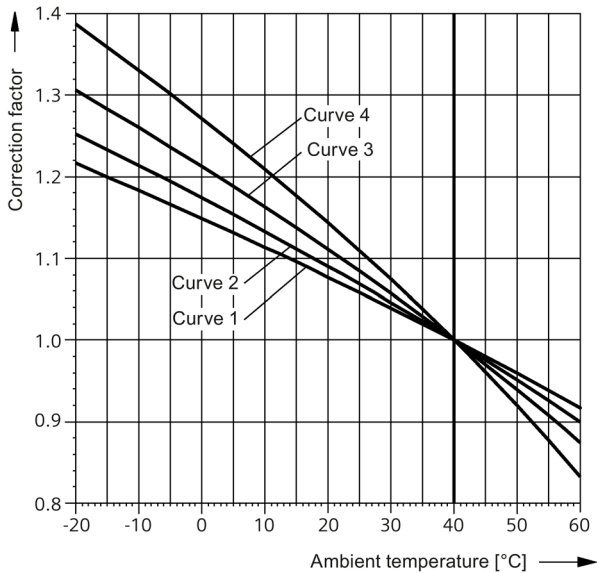

10.3 Conductor cross-sections

Table 10- 1 Correction factor for 5SJ4...-HG miniature circuit breakers
(see diagram for curves)

Rated current (A)	0.3	0.5	1	1.6	2	3	4	5	6	8	10	13
Number of poles	Valid curve for the correction factor for 5SJ4...-HG miniature circuit breakers											
1	4	4	4	4	3	3	2	2	2	2	3	3
2	4	4	3	3	3	3	2	2	2	2	3	3
3	4	4	3	3	3	3	2	2	2	2	3	3

Rated current (A)	15	16	20	25	30	32	35	40	45	50	60	63
Number of poles	Valid curve for the correction factor for 5SJ4...-HG miniature circuit breakers											
1	3	3	3	3	3	3	3	3	2	2	3	2
2	3	2	2	2	2	2	2	2	1	2	2	1
3	3	2	2	2	2	2	2	2	1	1	1	1

Current-carrying capacity at ambient temperatures other than 40 °C

In the event of ambient temperatures other than 40 °C, refer to the following table for the current-carrying capacity of the 5SJ4...-HG miniature circuit breakers.

Rated current I_n (A) at 40 °C		Permissible rated current I_n (A), depending on the ambient temperature						
Rated current I_n (A)	Number of poles	15 °C	20 °C	25 °C	30 °C	40 °C	50 °C	55 °C
0.3	1/2/3	0.35	0.34	0.33	0.32	0.30	0.28	0.26
0.5	1/2/3	0.59	0.57	0.55	0.54	0.50	0.46	0.44
1	1	1.2	1.1	1.1	1.1	1.0	0.9	0.9
	2/3	1.1	1.1	1.1	1.1	1.0	0.9	0.9
1.6	1	1.9	1.8	1.8	1.7	1.6	1.5	1.4
	2/3	1.8	1.8	1.7	1.7	1.6	1.5	1.5
2	1/2/3	2.3	2.2	2.2	2.1	2.0	1.9	1.8
3	1/2/3	3.4	3.3	3.3	3.2	3.0	2.8	2.7
4	1/2/3	4.5	4.4	4.3	4.2	4.0	3.8	3.7
5	1/2/3	5.6	5.5	5.3	5.2	5.0	4.8	4.6
6	1/2/3	6.7	6.5	6.4	6.3	6.0	5.7	5.6
8	1/2/3	8.9	8.7	8.6	8.4	8.0	7.6	7.4
10	1/2/3	11.4	11.1	10.8	10.6	10.0	9.4	9.1
13	1/2/3	14.8	14.4	14.1	13.7	13.0	12.2	11.8
15	1/2/3	17.1	16.7	16.3	15.9	15.0	14.1	13.6
16	1	18.2	17.8	17.4	16.9	16.0	15.0	14.5
	2/3	17.8	17.5	17.1	16.7	16.0	15.2	14.8
20	1	22.8	22.2	21.7	21.1	20.0	18.8	18.1
	2/3	22.3	21.8	21.4	20.9	20.0	19.0	18.5
25	1	28.4	27.8	27.1	26.4	25.0	23.5	22.7

Rated current I_n (A) at 40 °C		Permissible rated current I_n (A), depending on the ambient temperature						
Rated current I_n (A)	Number of poles	15 °C	20 °C	25 °C	30 °C	40 °C	50 °C	55 °C
30	2/3	27.8	27.3	26.7	26.2	25.0	23.8	23.1
	1	34.1	33.3	32.5	31.7	30.0	28.2	27.2
32	2/3	33.4	32.7	32.1	31.4	30.0	28.5	27.8
	1	36.4	35.6	34.7	33.8	32.0	30.1	29.0
35	2/3	35.6	34.9	34.2	33.5	32.0	30.4	29.6
	1	39.8	38.9	38.0	37.0	35.0	32.9	31.8
40	2/3	38.9	38.2	37.4	36.6	35.0	33.3	32.4
	1	45.5	44.5	43.4	42.3	40.0	37.6	36.3
45	2/3	44.5	43.6	42.8	41.9	40.0	38.0	37.0
	1	50.1	49.1	48.1	47.1	45.0	42.8	41.7
50	2/3	49.3	48.5	47.6	46.8	45.0	43.2	42.2
	1/2	55.6	54.6	53.5	52.3	50.0	47.6	46.3
60	3	49.3	48.5	47.6	52.0	50.0	48.0	46.9
	1	68.3	66.7	65.1	63.4	60.0	56.4	54.4
	2	66.8	65.5	64.1	62.8	60.0	57.1	55.5
63	3	65.7	64.6	63.5	62.4	60.0	57.5	56.3
	1	70.1	68.7	67.3	65.9	63.0	59.9	58.3
	2/3	69.0	67.9	66.7	65.5	63.0	60.4	59.1

Let-through I^2t values 5SJ4...-HG40/41

Characteristic B

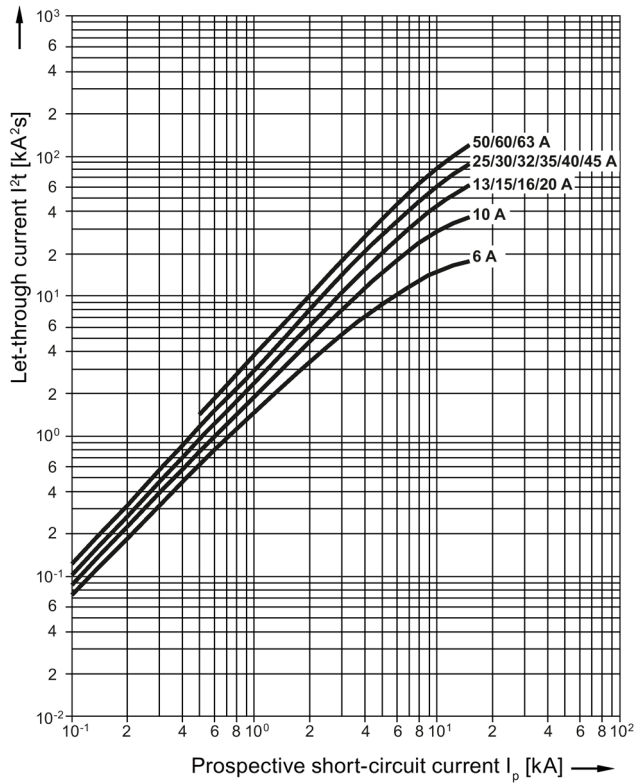

Characteristic C

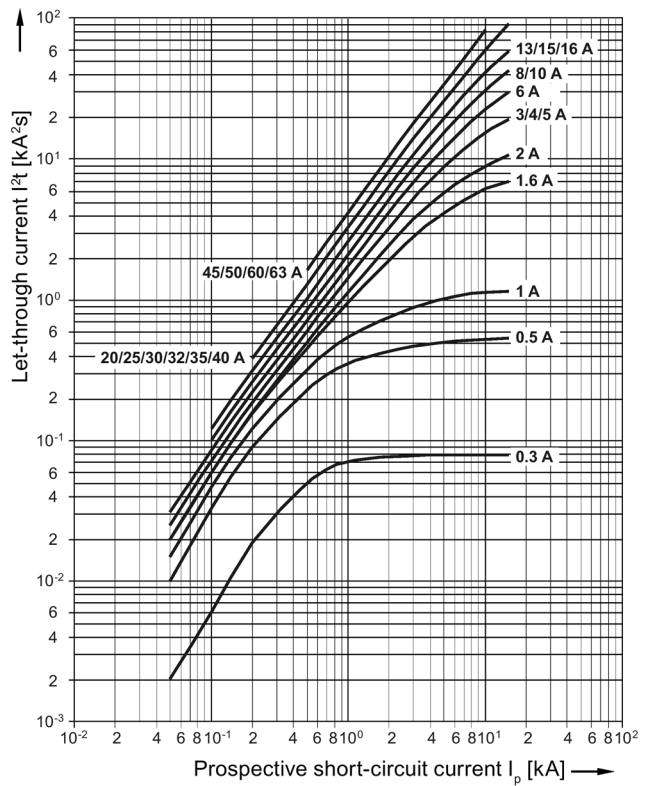

Characteristic D

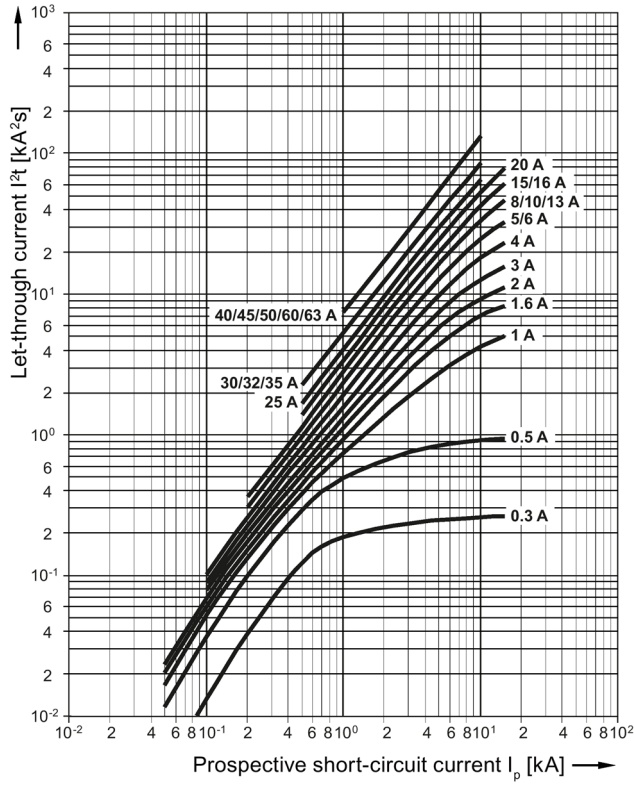

Let-through I^2t values 5SJ4...-HG42

Characteristic C

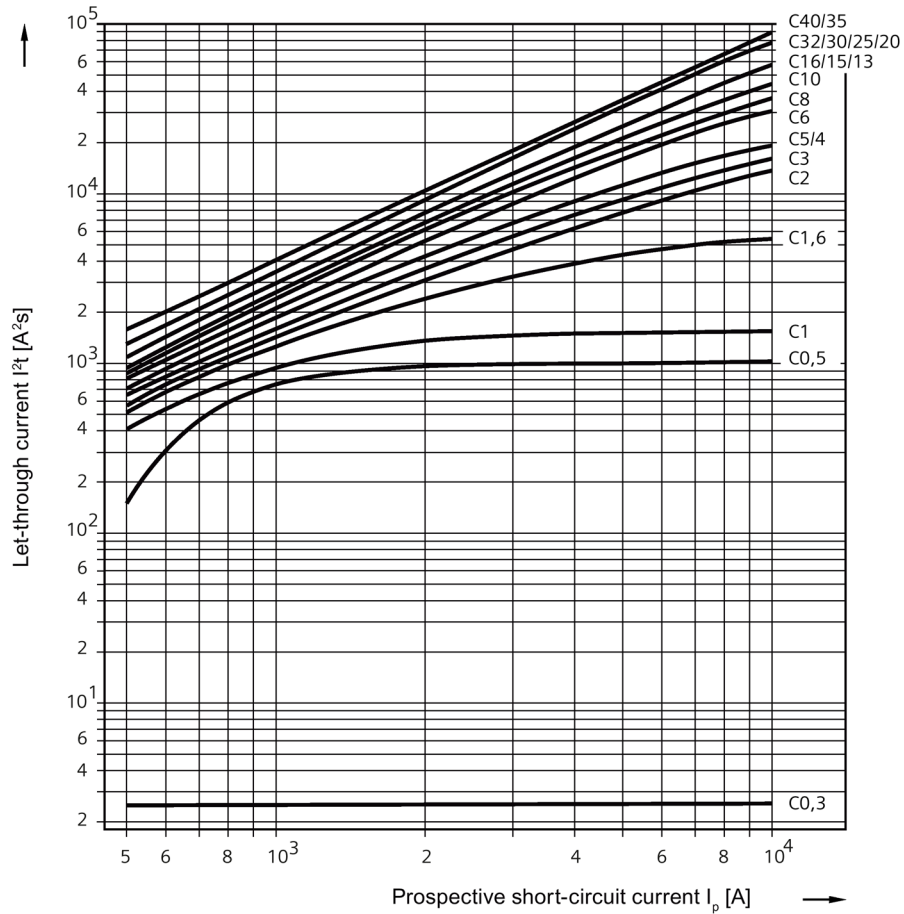

Characteristic D

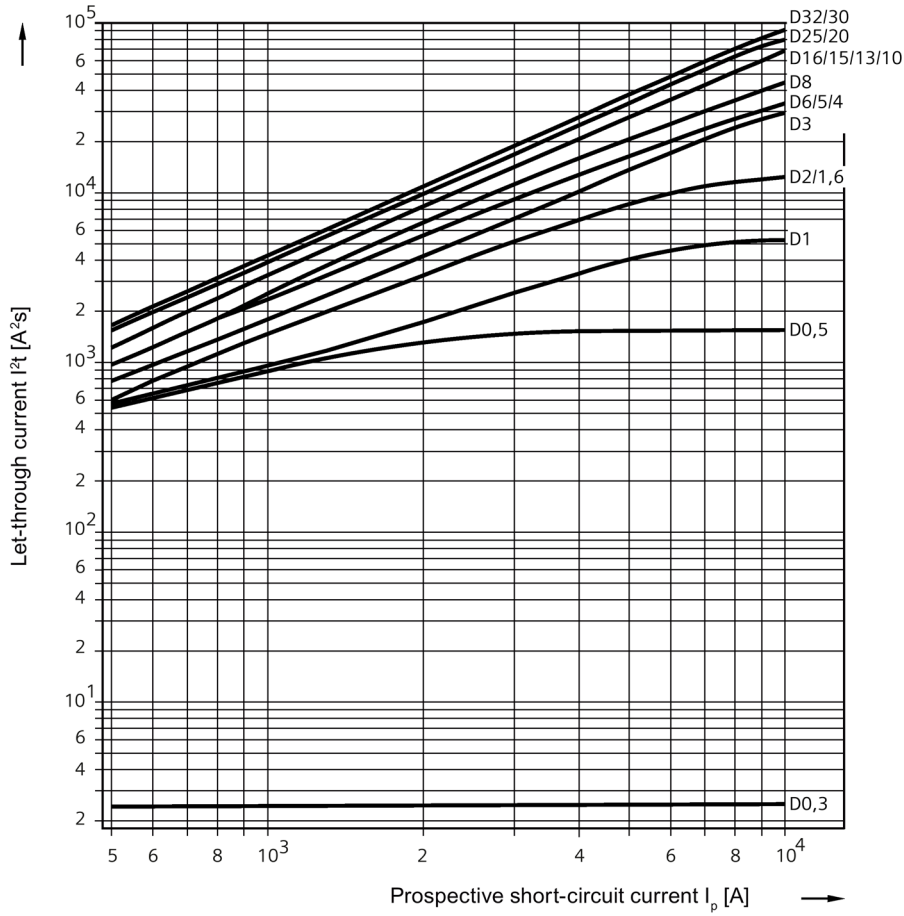

Correction factors for rated switching capacities I_{cn} depending on altitude above sea level

Altitude above sea level / m	Correction factor	I_{cn} / kA 5SJ4...HG
500	1	10
1000	1	10
1500	1	10
2000	1	10
2500	0.94	9.4
3000	0.88	8.8
3500	0.83	8.3
4000	0.78	7.8

10.4 Correction factors for rated current if bundling

10.4 Correction factors for rated current if bundling

If more than one electrical circuit is loaded in a series of miniature circuit breakers the resulting increase in ambient temperature affects the characteristic curve. In this case an additional correction factor, specific to the rated current of the miniature circuit breaker, must be taken into account.

Number of MCBs	1	2 ... 3	4 ... 6	> 7
Correction factor K	1.00	0.90	0.88	0.85

Correction factors for rated current at different frequencies

The tripping characteristic applies to a frequency of 50 Hz to 60 Hz. In the case of other frequencies, the following correction factors must be taken into account.

In the overload range, the limits of the characteristic curves correspond to the correction factors of the thermal tripping operation. In the event of a short-circuit, the limits of the characteristic curves correspond to the correction factors of the magnetic tripping operation.

Thermal tripping operation

	Rated current I_n (A)	Correction factor for					
		0 Hz	16 2/3 Hz	50/60 Hz	125 Hz	400 Hz	1000 Hz
5SY	0.3 ... 10	1	1	1	1	0.99	0.97
	1 ... 40	1	1	1	0.98	0.97	0.93
	50 ... 63	1	1	1	0.98	0.94	0.86

*) 5SY: Exceptions for DC, see page Technical specifications (Page 20) therm. and magn.

Magnetic tripping operation

	Rated current I_n (A)	Correction factor for					
		0 Hz	16 2/3 Hz	50/60 Hz	125 Hz	400 Hz	1000 Hz
5SY	0.3 ... 63	1.4	1	1	1.2	1.4	1.7

10.5 Dimensional drawings

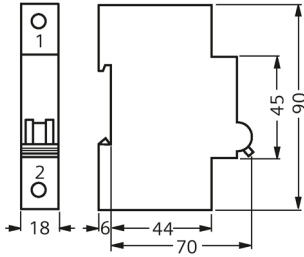

5SJ4...-HG40

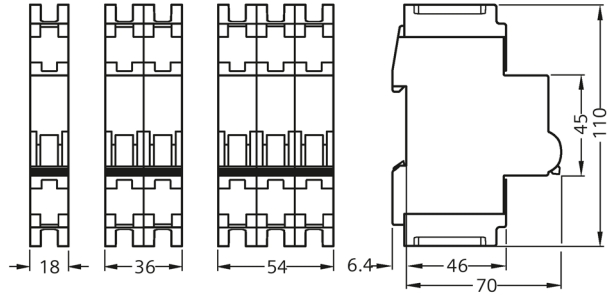

5SJ4...-HG41

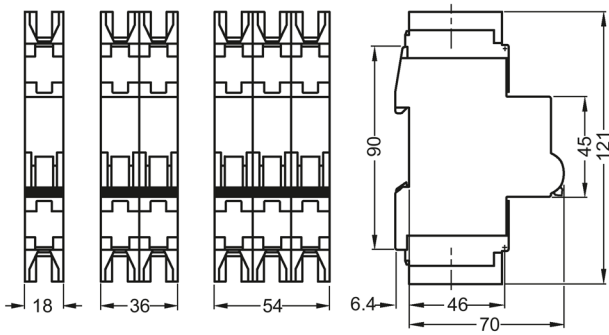

5SJ4...-HG42

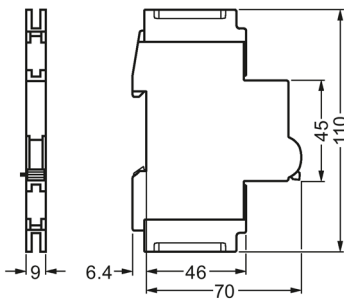

5ST3010-0HG

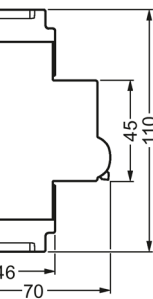

5ST3011-0HG



5ST3012-0HG

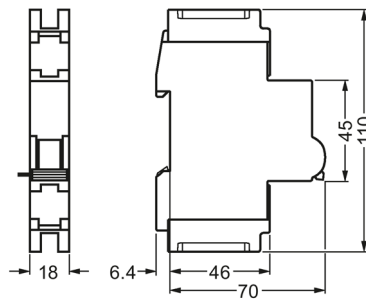

5ST3030-0HG

5ST3020-0HG

5ST3021-0HG

5ST3022-0HG

5ST3031-0HG

10.5 Dimensional drawings

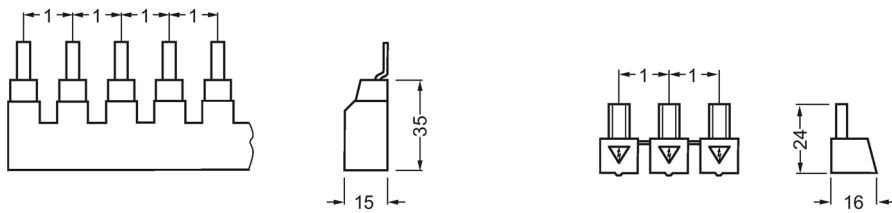

5ST3663-0HG 5ST3664-0HG 5ST3665-0HG 5ST3666-1HG
 5ST3663-1HG 5ST3664-1HG 5ST3665-1HG
 5ST3663-2HG 5ST3664-2HG 5ST3665-2HG

Note

Pin spacing in MW
 Dimensions of side view in mm (approx.)

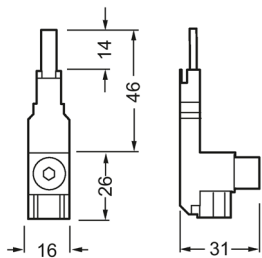

5ST3666-0HG

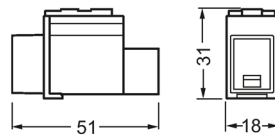

5ST3666-2HG

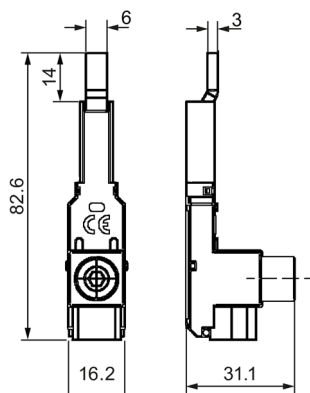

5ST3770-3HG

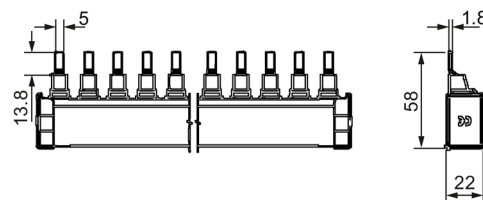

5ST37...-3HG

10.6 Circuit diagrams

Miniature circuit breakers

5SJ4 ... HG



1P



2P



3P

Additional components

Auxiliary switches (AS)



5ST3010-0HG



5ST3011-0HG



5ST3012-0HG

Fault signal contacts (FC)



5ST3020-0HG



5ST3021-0HG



5ST3022-0HG

Shunt trips (ST)

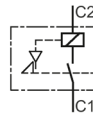

5ST3030-0HG

5ST3031-0HG

10.7 More information

Rated switching capacity acc. to UL 489

Designation	Characteristic	Current	Rated switching capacity (operational voltage 240 V AC)	Rated switching capacity (operational voltage 480Y/277 V AC)
		A	kA AC	kA AC
5SJ4...-HG40	B	6 ... 63	14	--
	C	0.3 ... 40	14	--
	C	45 ... 63	10	--
	D	0.3 ... 20	14	--
	D	25 ... 63	10	--
5SJ4...-HG41	C	0.3 ... 40	14	--
	C	45 ... 63	10	--
	D	0.3 ... 20	14	--
	D	25 ... 63	10	--
5SJ4...-HG42	C	0.3 ... 40	14	10
	D	0.3 ... 20	14	10
	D	25 ... 32	10	10

Internal resistance and power loss per pole at I_n

Rated current	Characteristic B		Characteristic C		Characteristic D	
	R_i	P_v	R_i	P_v	R_i	P_v
I_n	$m\Omega$	W	$m\Omega$	W	$m\Omega$	W
0.3	--	--	12900	1.2	12600	1.1
0.5	--	--	4900	1.2	4600	1.2
1	--	--	1650	1.7	1480	1.5
1.6	--	--	620	1.6	570	1.5
2	--	--	440	1.8	435	1.8
3	--	--	197	1.8	190	1.7
4	--	--	115	1.8	100	1.6
5	--	--	115	2.9	100	2.5
6	85	3.1	74	2.7	73	2.6
8	--	--	40	2.6	39	2.5
10	16.5	1.7	13.5	1.4	11.9	1.2
13	11.7	2.0	10.2	1.7	10.2	1.7
15	8.5	1.9	7.8	1.8	7.7	1.7
16	8.5	2.2	7.8	2.0	7.7	2.0
20	6.7	2.7	5.5	2.2	5.5	2.2
25	4.3	2.7	4.2	2.6	4.2	2.6
30	3.4	3.1	3.5	3.2	3.0	2.7
32	3.4	3.5	3.5	3.6	3.0	3.1
35	2.8	3.4	2.8	3.4	2.7	3.3
40	2.8	4.5	2.8	4.5	2.5	4.0
45	2.8	5.7	2.7	5.5	2.5	5.1
50	2.1	5.3	2.1	5.0	2.0	5.0
60	1.7	6.1	1.7	6.1	1.7	6.1
63	1.7	6.7	1.7	6.7	1.7	6.7

SHU 5SP3 main miniature circuit breakers

11.1 Overview

The selective main miniature circuit breaker is used as a circuit breaker on meter panels.

Characteristic E is adapted to the special application requirements for cascade circuits between melting fuses and miniature circuit breakers in distributor circuits.

Used in conjunction with downstream miniature circuit breakers, SHU 5SP3 main miniature circuit breakers ensure effective protection and optimum availability of the plant.

11.2 Benefits

- Quick and easy installation on busbar and DIN rail
- Reliable and high selectivity
- Optimum availability of the consumer load
- The SHU 5SP3 main miniature circuit breaker operates on a voltage-independent basis
- High and safe selectivity between sub-distribution and meter panel ensures the continued supply of the unaffected circuits in the event of a fault, thus improving system availability
- In the event of a fault, the SHU 5SP3 main miniature circuit breaker prevents an existing short-circuit from being reconnected until the cause of the fault has been eliminated
- The SHU 5SP3 selective main miniature circuit breaker ensures fast and safe disconnection and reconnection of loads
- It complies with all the requirements of TAB 2007 and can therefore be used in metering systems

11.3 Technical specifications

Miniature Circuit Breakers		Unit	5SP37..-2, 5SP37..-2KK0.	5SP38..-2
Standards			DIN VDE 0641-21	
Rated voltage U_n				
• 1-pole		V AC	230 / 400	--
• 3 x 1-pole		V AC	--	400
Operational voltage	Min.	V AC	110	
	Max.	V AC	440	
Rated frequency		Hz	50 / 60	
Rated current I_n		A	16 ... 63	
Rated insulation voltage U_i		V AC	690	
Rated switching capacity I_{cn}		A	25000	
Insulation coordination				
• Overvoltage category			IV	
• Pollution degree			3	
Impulse withstand voltage U_{imp}		kV	6	
Impact resistance			30 g, at least 3 impacts, impact duration 11 ms	
Resistance to vibrations			2 g, 20 frequency cycles 5 ... 150 ... 15 Hz	
Switch position indicator			OFF = green, ON = red	
Main switch characteristics	Acc. to EN 60204-1		Yes	
Handle end position, sealable			Yes	
Cutoff		ON/OFF	Locking slide with lock, additional wire seal, cable ties and Antilux	
Device depth		mm	92	
Degree of protection			IP20, with connected conductors	
Mains connection			Any	
Mounting position			Any	
Vertical device clearance with DIN rails mounted one above the other (grid distance acc. to IEC/EN 60898-1) ¹⁾		mm	100	
Mounting			Direct tool-free mounting on the busbar system	
Service life/endurance, on average, with rated load		Actuations	20000	
Conductor connections				
• Top			Screwless spring terminal for flexible cables, in particular for meter connecting cables acc. to DIN 43870-3	
• Bottom			Box terminal, also for infeed to the busbar system, up to 100 A infeed current	

11.3 Technical specifications

Miniature Circuit Breakers	Unit	5SP37..-2, 5SP37..-2KK0.	5SP38..-2
Conductor cross-sections			
• Top and bottom, solid and stranded	mm ²	--	
• Top and bottom, finely stranded	mm ²	--	
• Top, finely stranded	mm ²	2.5 ... 16	
• Bottom, solid, stranded and finely stranded, with end sleeve	mm ²	2.5 ... 50	
Storage temperature	°C	-40 ... +70	
Ambient temperature	°C	-25 ... +55	

¹⁾ For more explanations and application notes, see Consideration of minimum clearances (Page 99)

Miniature Circuit Breakers		Type	5SP37...-3	5SP38...-3	5SP32...-3	5SP33...-3	5SP34...-3
Standards			DIN VDE 0641-21				
Rated voltage U_n							
• 1-pole	V AC	230	--	--	--	--	--
• 3 x 1-pole	V AC	--	230	--	--	--	--
• 2-pole	V AC	--	--	400	--	--	--
• 3-pole	V AC	--	--	--	400	--	--
• 4-pole	V AC	--	--	--	--	400	--
Operational voltage	Min.	V AC	110				
	Max.	V AC	440				
Rated frequency		Hz	50 / 60				
Rated current I_n		A	16 ... 63				
Rated insulation voltage U_i		V AC	690				
Rated switching capacity I_{cn}		A	25000				
Insulation coordination							
Overvoltage category			IV				
Pollution degree			3				
Impulse withstand voltage U_{imp}		kV	6				
Impact resistance			25 g, at least 3 impacts, impact duration 13 ms				
Resistance to vibrations			2 g, 20 frequency cycles 5 ... 150 ... 15 Hz				
Switch position indicator			OFF = green, ON = red				
Main switch characteristics	Acc. to EN 60204-1		Yes				
Handle end position, sealable			Yes				
Cutoff	ON/OFF		Integrated locking slide, lockable by means of a lock, wire seal and cable ties				
Device depth	mm		91.1				
Degree of protection			IP40, with mounted distribution cover, cutout dimension 46 mm				
Mains connection			Any				
Mounting position			Any				
Mounting			On DIN rail 35 mm acc. to EN 60715				
Conductor connections			Box terminal				
Conductor cross-sections							
Top and bottom, solid, stranded and finely stranded		mm ²	2.5 ... 50				
Storage temperature		°C	-40 ... +70				
Ambient temperature		°C	-25 ... +55				

11.4 Configuration

Internal resistances and power losses

- Internal resistances per pole in $m\Omega$ cold state
- Power loss per pole in W for rated current

Type	Rated current	R_i	P_{max}
	A	$m\Omega$	W
5SP37...-2, 5SP37...-2KK0., 5SP38...-2	16	15.3	4.5
	20	11.3	6.0
	25	8.7	6.5
	35	4.5	6.9
	40	3.8	6.4
	50	3.5	8.0
	63	2.3	9.7
5SP3...-3	16	15.3	4.1
	20	11.3	5.4
	25	8.7	5.9
	35	4.5	6.3
	40	3.4	6.1
	50	2.9	7.6
	63	2.1	8.7

Selectivity

Short-circuit selectivity between the SHU 5SP3 main miniature circuit breakers and downstream 5SL/5SY miniature circuit breakers

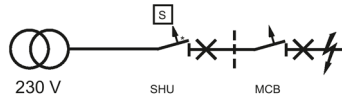

Due to its principle of action, the SHU 5SP3 main miniature circuit breaker is always short-circuit-selective up to the rated switching capacity of the downstream 5SL/5SY miniature circuit breaker, e.g. 6000 A or 10000 A.

Selectivity of the SHU 5SP3 main miniature circuit breaker for the upstream fuse 3NA gG

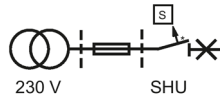

		Selectivity of the SHU 5SP3... main miniature circuit breaker for the upstream fuse 3NA... [kA]												
Fuse		3NA												
Operational class		gG												
Rated voltage U_n [AC V]		230/400												
Downstream main miniature circuit breaker (SHU)		Back-up fuse:												
		32	35	40	50	63	80	100	125	160	200	224	250	300
SHU type: 5SP3... Characteristic E I_{cn} [kA] = 25 kA	E 16	--	0.55	0.75	1.1	1.9	3.3	8	14.6	T	T	T	T	T
	E 20	--	0.48	0.6	0.9	1.5	2.5	4.5	7.2	12.8	T	T	T	T
	E 25	--	0.48	0.6	0.9	1.5	2.5	4.5	7.2	12.8	T	T	T	T
	E 35	--	--	0.6	0.9	1.5	2.5	4.5	7.2	12.8	T	T	T	T
	E 40	--	--	--	0.7	1.3	2	3.6	5.5	8.9	T	T	T	T
	E 50	--	--	--	--	1.3	2	3.6	5.5	8.9	T	T	T	T
	E 63	--	--	--	--	1.3	2	3.6	5.5	8.9	T	T	T	T

11.4 Configuration

	Selectivity of the SHU 5SP3... main miniature circuit breaker for the upstream fuse 3NA... [kA]
Fuse	3NA
Operational class	gG
Rated voltage U_n [AC V]	230/400
Downstream main	Back-up fuse:

T: Total selectivity up to the rated switching capacity I_{cn} of the downstream SHU 5SP3 main miniature circuit breaker

Selectivity for the cascade: Fuse 3NA gG – SHU 5SP3 main miniature circuit breaker – 5SL/5SY miniature circuit breaker

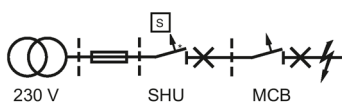

In a cascade connection¹⁾ with upstream fuse, SHU 5SP3 main miniature circuit breaker and miniature circuit breaker, the following values result:

	Selectivity for the cascade: Fuse 3NA gG – SHU 5SP3 main miniature circuit breaker – 5SL/5SY miniature circuit breaker [kA]																
Fuse	3NA																
Operational class	gG																
Rated voltage U_n [V AC]	230/400																
SHU	5SP3...																
Characteristic	E																
Downstream miniature circuit breakers	Back-up fuse:																
		63 A				80 A				100 A				125 A			
	I_n [A]	E35	E40	E50	E63	E35	E40	E50	E63	E35	E40	E50	E63	E35	E40	E50	E63
Circuit breaker type: 5SY4...-. 5SL4...-. Characteristic B/C I_{cn} [kA] = 10	0.3	T	T	T	T	T	T	T	T	T	T	T	T	T	T	T	T
	0.5	T	T	T	T	T	T	T	T	T	T	T	T	T	T	T	T
	1	T	T	T	T	T	T	T	T	T	T	T	T	T	T	T	T
	1.5	T	T	T	T	T	T	T	T	T	T	T	T	T	T	T	T
	2	T	T	T	T	T	T	T	T	T	T	T	T	T	T	T	T
	3	T	T	T	T	T	T	T	T	T	T	T	T	T	T	T	T
	4	T	T	T	T	T	T	T	T	T	T	T	T	T	T	T	T
	6	7	7	7	7	T	T	T	7	T	T	T	T	T	T	T	T
	8	7	6	6	5	T	T	T	7	T	T	T	T	T	T	T	T
	10	6	6	6	5	7	7	7	7	T	T	T	T	T	T	T	T
	13	6	6	6	5	7	7	7	6	T	T	T	T	T	T	T	T
	16	5	5	5	4	7	7	7	6	T	T	T	T	T	T	T	T
20	--	4	4.5	4	--	7	6	6	--	T	T	T	--	T	T	T	
25	--	--	4	3	--	--	6	5.5	--	--	T	T	--	--	T	T	

	Selectivity for the cascade: Fuse 3NA gG – SHU 5SP3 main miniature circuit breaker – 5SL/5SY miniature circuit breaker [kA]																
Fuse	3NA																
Operational class	gG																
Rated voltage U_n [V AC]	230/400																
SHU	5SP3...																
Characteristic	E																
Downstream	Back-up fuse:																
	32	--	--	--	3	--	--	--	5	--	--	--	7	--	--	--	T
	40	--	--	--	--	--	--	--	--	--	--	--	--	--	--	--	--
	50	--	--	--	--	--	--	--	--	--	--	--	--	--	--	--	--
	63	--	--	--	--	--	--	--	--	--	--	--	--	--	--	--	--

T: Total selectivity up to the rated switching capacity I_{cn} of the downstream miniature circuit breaker.

- 1) The selectivity limit results from the intersection of the let-through I^2t value of the SHU 5SP3 main miniature circuit breaker and miniature circuit breaker combination with the melting integral of the fuse according to EN 60269 (VDE 0636).

	Selectivity for the cascade: Fuse 3NA gG – SHU 5SP3 main miniature circuit breaker – 5SL/5SY miniature circuit breaker [kA]																
Fuse	3NA																
Operational class	gG																
Rated voltage U_n [V AC]	230/400																
SHU	5SP3...																
Characteristic	E																
Downstream miniature circuit breakers	Back-up fuse:																
		63 A				80 A				100 A				125 A			
	I_n [A]	E35	E40	E50	E63	E35	E40	E50	E63	E35	E40	E50	E63	E35	E40	E50	E63
Circuit breaker type: 5SY4...-8 5SL4...-8 Characteristic B/C I_{cn} [kA] = 10	0.3	T	T	T	T	T	T	T	T	T	T	T	T	T	T	T	T
	0.5	T	T	T	T	T	T	T	T	T	T	T	T	T	T	T	T
	1	T	T	T	T	T	T	T	T	T	T	T	T	T	T	T	T
	1.5	T	T	T	T	T	T	T	T	T	T	T	T	T	T	T	T
	2	T	T	T	T	T	T	T	T	T	T	T	T	T	T	T	T
	3	T	T	T	T	T	T	T	T	T	T	T	T	T	T	T	T
	4	7	7	7	7	T	T	T	7	T	T	T	T	T	T	T	T
	6	7	6	6	6	T	T	T	7	T	T	T	T	T	T	T	T
	8	6	6	6	5	7	7	7	7	T	T	T	T	T	T	T	T
	10	6	6	6	5	7	7	7	6	T	T	T	T	T	T	T	T
13	5.5	6	5.5	4	7	7	7	6	T	T	T	T	T	T	T	T	
16	5	4.5	4.5	4	6	7	7	6	7	T	T	T	T	T	T	T	

11.4 Configuration

	Selectivity for the cascade: Fuse 3NA gG – SHU 5SP3 main miniature circuit breaker – 5SL/5SY miniature circuit breaker [kA]																
Fuse	3NA																
Operational class	gG																
Rated voltage U_n [V AC]	230/400																
SHU	5SP3...																
Characteristic	E																
Downstream	Back-up fuse:																
	20	--	3.5	4	3.5	--	6	6	5.5	--	7	T	T	--	T	T	T
	25	--	--	3.5	3	--	--	5.5	5	--	--	7	7	--	--	T	T
	32	--	--	--	2.5	--	--	--	4.5	--	--	--	6	--	--	--	T
	40	--	--	--	--	--	--	--	--	--	--	--	--	--	--	--	--
	50	--	--	--	--	--	--	--	--	--	--	--	--	--	--	--	--
	63	--	--	--	--	--	--	--	--	--	--	--	--	--	--	--	--

T: Total selectivity up to the rated switching capacity I_{cn} of the downstream miniature circuit breaker.

	Selectivity for the cascade: Fuse 3NA gG – SHU 5SP3 main miniature circuit breaker – 5SL/5SY miniature circuit breaker [kA]																
Fuse	3NA																
Operational class	gG																
Rated voltage U_n [V AC]	230/400																
SHU	5SP3...																
Characteristic	E																
Downstream miniature circuit breakers	Back-up fuse:																
	63 A					80 A					100 A					125 A	
	SHU																
	I_n [A]	E35	E40	E50	E63	E35	E40	E50	E63	E35	E40	E50	E63	E35	E40	E50	E63
Circuit breaker type: 5SY6, 5SL6...- (without 5SL60) Characteristic B/C I_{cn} [kA] = 6	0.3	T	T	T	T	T	T	T	T	T	T	T	T	T	T	T	T
	0.5	T	T	T	T	T	T	T	T	T	T	T	T	T	T	T	T
	1	T	T	T	T	T	T	T	T	T	T	T	T	T	T	T	T
	1.5	T	T	T	T	T	T	T	T	T	T	T	T	T	T	T	T
	2	T	T	T	T	T	T	T	T	T	T	T	T	T	T	T	T
	3	T	T	T	T	T	T	T	T	T	T	T	T	T	T	T	T
	4	T	T	T	T	T	T	T	T	T	T	T	T	T	T	T	T
	6	T	T	T	T	T	T	T	T	T	T	T	T	T	T	T	T
	8	T	T	T	5	T	T	T	T	T	T	T	T	T	T	T	T
	10	T	T	T	5	T	T	T	T	T	T	T	T	T	T	T	T
13	T	T	T	5	T	T	T	T	T	T	T	T	T	T	T	T	
16	5	5	5	4	T	T	T	T	T	T	T	T	T	T	T	T	

	Selectivity for the cascade: Fuse 3NA gG – SHU 5SP3 main miniature circuit breaker – 5SL/5SY miniature circuit breaker [kA]																
Fuse	3NA																
Operational class	gG																
Rated voltage U_n [V AC]	230/400																
SHU	5SP3...																
Characteristic	E																
Downstream	Back-up fuse:																
	20	--	4	4.5	4	--	T	T	T	--	T	T	T	--	T	T	T
	25	--	--	4	3	--	--	T	5.5	--	--	T	T	--	--	T	T
	32	--	--	--	3	--	--	--	5	--	--	--	T	--	--	--	T
	40	--	--	--	--	--	--	--	--	--	--	--	--	--	--	--	--
	50	--	--	--	--	--	--	--	--	--	--	--	--	--	--	--	--
	63	--	--	--	--	--	--	--	--	--	--	--	--	--	--	--	--

	Selectivity for the cascade: Fuse 3NA gG – SHU 5SP3 main miniature circuit breaker – 5SL/5SY miniature circuit breaker [kA]																
Fuse	3NA																
Operational class	gG																
Rated voltage U_n [V AC]	230/400																
SHU	5SP3...																
Characteristic	E																
Downstream miniature circuit breakers	Back-up fuse:																
	63 A				80 A				100 A				125 A				
	SHU																
	I_n [A]	E35	E40	E50	E63	E35	E40	E50	E63	E35	E40	E50	E63	E35	E40	E50	E63
Circuit breaker type: 5SY7...-. Characterist ic B/C I_{cn} [kA] = 15	0.3	T	T	T	T	T	T	T	T	T	T	T	T	T	T	T	T
	0.5	T	T	T	T	T	T	T	T	T	T	T	T	T	T	T	T
	1	T	T	T	T	T	T	T	T	T	T	T	T	T	T	T	T
	1.5	T	T	T	T	T	T	T	T	T	T	T	T	T	T	T	T
	2	T	T	T	T	T	T	T	T	T	T	T	T	T	T	T	T
	3	T	T	T	T	T	T	T	T	T	T	T	T	T	T	T	T
	4	10	10	10	10	T	T	T	T	T	T	T	T	T	T	T	T
	6	7	7	7	7	T	T	T	7	T	T	T	T	T	T	T	T
	8	7	6	6	5	T	T	T	7	T	T	T	T	T	T	T	T
	10	6	6	6	5	7	7	7	7	T	T	T	T	T	T	T	T
	13	6	6	6	5	7	7	7	6	10	10	10	10	T	T	T	T
16	5	5	5	4	7	7	7	6	10	10	10	10	T	T	T	T	
20	--	4	4.5	4	--	7	6	6	--	10	10	10	--	T	T	T	
25	--	--	4	3	--	--	6	5.5	--	--	10	10	--	--	10	10	
32	--	--	--	3	--	--	--	5	--	--	--	7	--	--	--	10	

11.4 Configuration

	Selectivity for the cascade: Fuse 3NA gG – SHU 5SP3 main miniature circuit breaker – 5SL/5SY miniature circuit breaker [kA]																
Fuse	3NA																
Operational class	gG																
Rated voltage U_n [V AC]	230/400																
SHU	5SP3...																
Characteristic	E																
Downstream	Back-up fuse:																
	40	--	--	--	--	--	--	--	--	--	--	--	--	--	--	--	--
	50	--	--	--	--	--	--	--	--	--	--	--	--	--	--	--	--
	63	--	--	--	--	--	--	--	--	--	--	--	--	--	--	--	--

T: Total selectivity up to the rated switching capacity I_{cn} of the downstream miniature circuit breaker.

	Selectivity for the cascade: Fuse 3NA gG – SHU 5SP3 main miniature circuit breaker – 5SL/5SY miniature circuit breaker [kA]																
Fuse	3NA																
Operational class	gG																
Rated voltage U_n [V AC]	230/400																
SHU	5SP3...																
Characteristic	E																
Downstream miniature circuit breakers	Back-up fuse:																
		63 A				80 A				100 A				125 A			
	I_n [A]	E35	E40	E50	E63	E35	E40	E50	E63	E35	E40	E50	E63	E35	E40	E50	E63
Circuit breaker type: 5SY7...-8 Characteristic B/C I_{cn} [kA] = 15	0.3	T	T	T	T	T	T	T	T	T	T	T	T	T	T	T	T
	0.5	T	T	T	T	T	T	T	T	T	T	T	T	T	T	T	T
	1	T	T	T	T	T	T	T	T	T	T	T	T	T	T	T	T
	1.5	T	T	T	T	T	T	T	T	T	T	T	T	T	T	T	T
	2	T	T	T	T	T	T	T	T	T	T	T	T	T	T	T	T
	3	10	10	10	10	T	T	T	T	T	T	T	T	T	T	T	T
	4	7	7	7	7	T	T	T	10	T	T	T	T	T	T	T	T
	6	7	6	6	6	T	T	T	7	T	T	T	T	T	T	T	T
	8	6	6	6	5	10	10	10	7	T	T	T	T	T	T	T	T
	10	6	6	6	5	7	7	7	6	10	10	10	10	T	T	T	T
	13	5	5	5	4.5	7	7	7	6	10	10	10	10	T	T	T	T
	16	4.5	4.5	4.5	4	6	7	6	6	10	10	10	10	10	T	T	T
	20	--	3.5	4	3.5	--	6	6	5.5	--	10	10	10	--	10	10	10
	25	--	--	3.5	3	--	--	5	5	--	--	7	7	--	--	10	10
32	--	--	--	2.5	--	--	--	4.5	--	--	--	6	--	--	--	10	
40	--	--	--	--	--	--	--	--	--	--	--	--	--	--	--	--	

	Selectivity for the cascade: Fuse 3NA gG – SHU 5SP3 main miniature circuit breaker – 5SL/5SY miniature circuit breaker [kA]																
Fuse	3NA																
Operational class	gG																
Rated voltage U_n [V AC]	230/400																
SHU	5SP3...																
Characteristic	E																
Downstream	Back-up fuse:																
	50	--	--	--	--	--	--	--	--	--	--	--	--	--	--	--	--
	63	--	--	--	--	--	--	--	--	--	--	--	--	--	--	--	--

T: Total selectivity up to the rated switching capacity I_{cn} of the downstream miniature circuit breaker.

11.5 Characteristic curves

Characteristic E acc. to DIN VDE 0641-21

5SP3.16-3; 5SP3.20-3; 5SP3.25-3

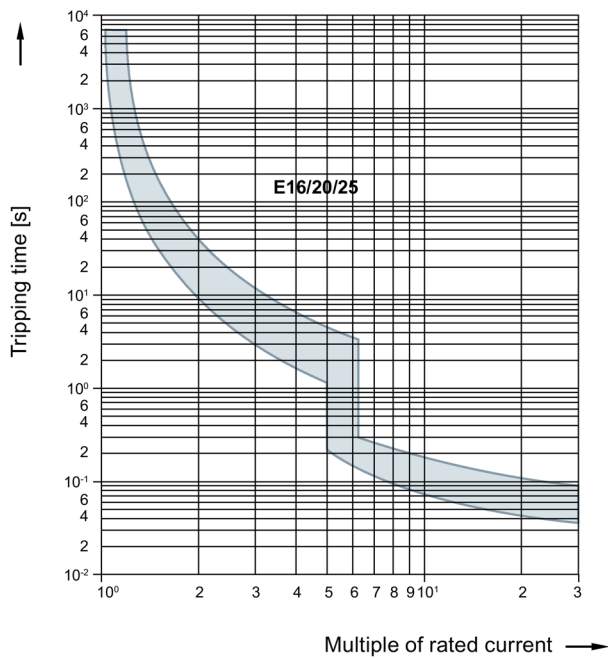

5SP3.16-3; 5SP3.40-3; 5SP3.50-3; 5SP3.63-3

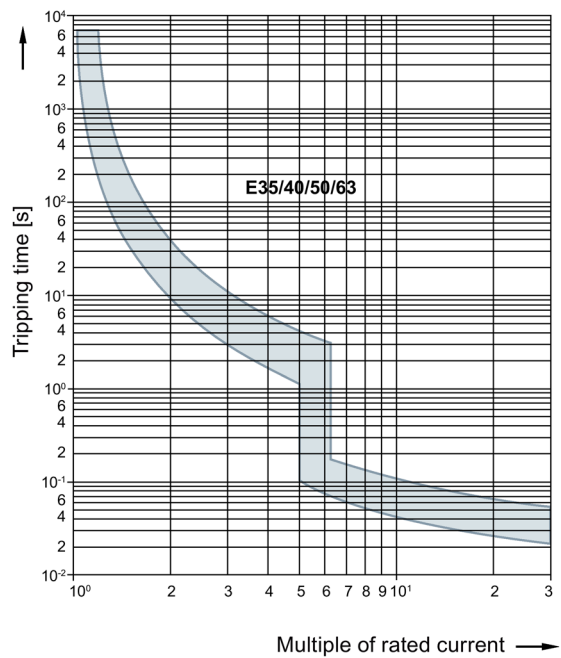

Let-through current I_{max} for SHU breakers

5SP3...-2; 5SP37..-2KK0.; 5SP,...-3; 16 ... 63 A

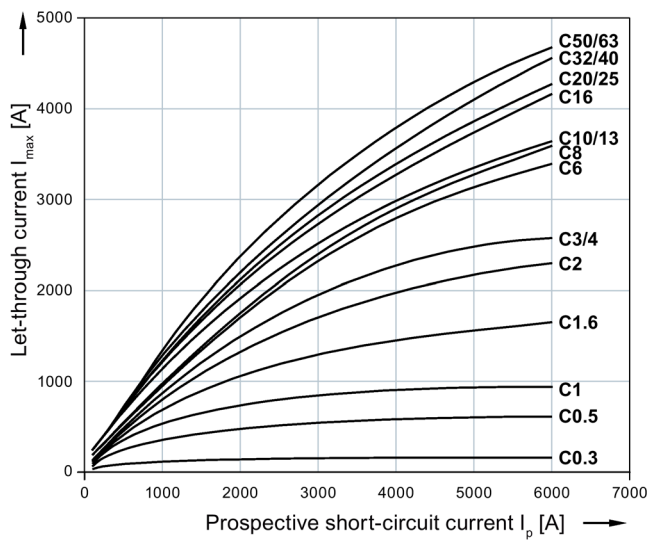

Let-through current
5SP3...-3

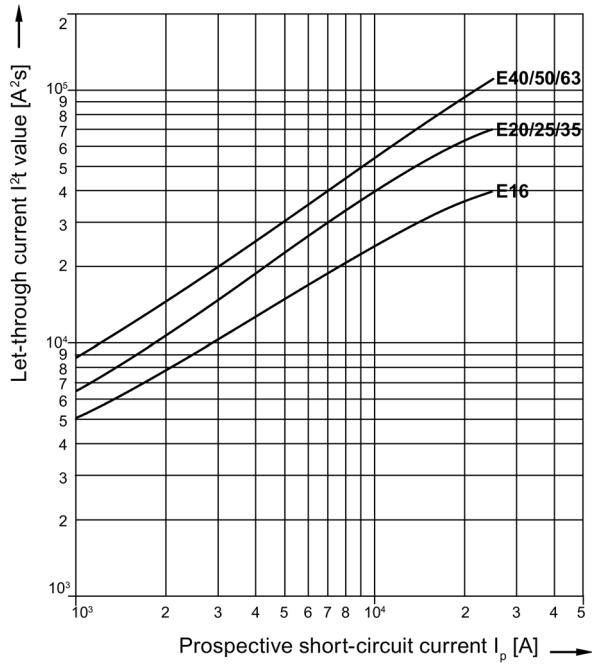

Let-through I^2t values
5SP3...-3

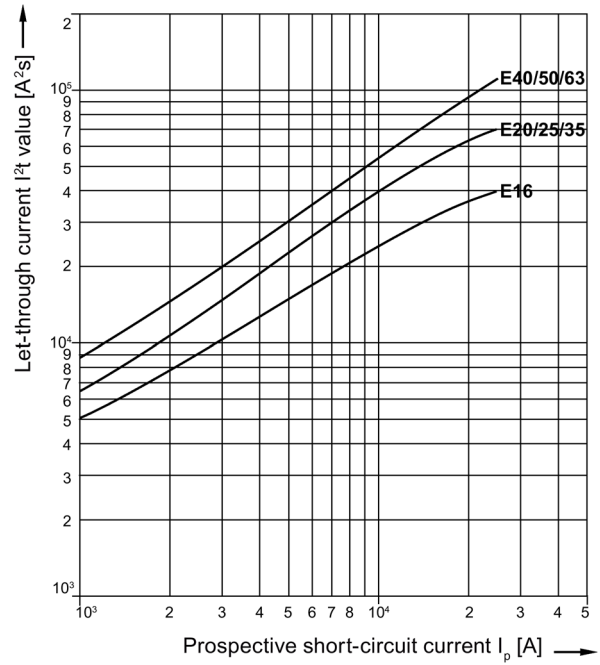

11.5 Characteristic curves

Let-through I^2t values for SHU breakers

5SP3...-2; 5SP37...-2KK0; 5SP3...-3; 16 ... 63 A

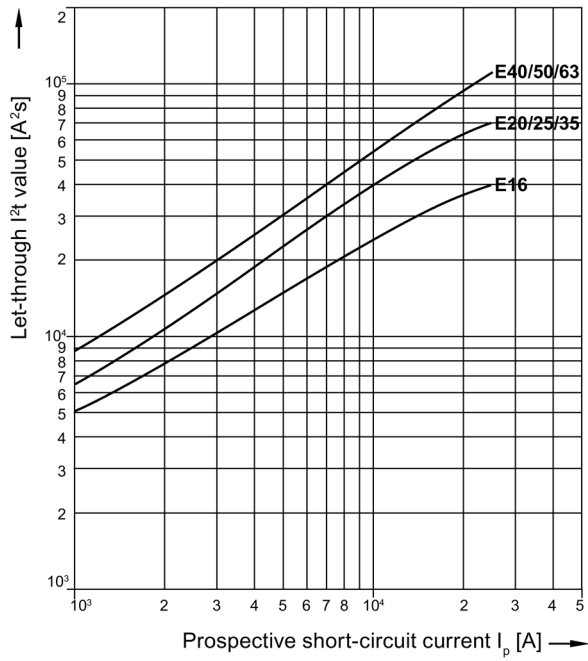

11.6 Dimensional drawings

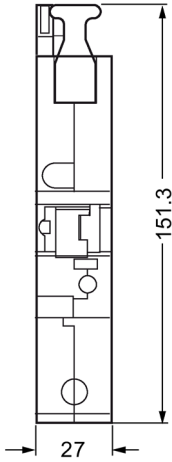

5SP37..-2
5SP37..-2KK0.
1P

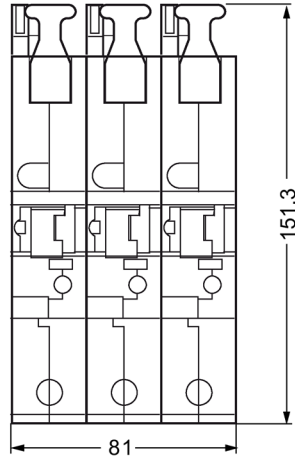

5SP38..-2
3x1P

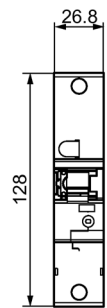
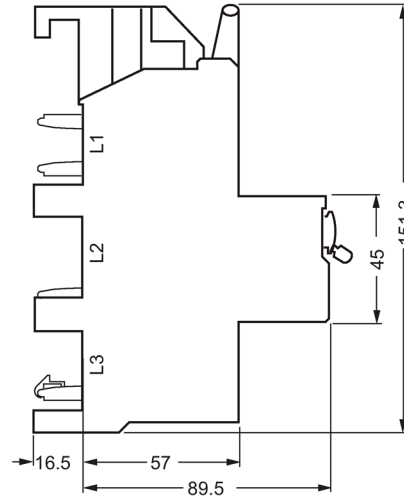

5SP37..-3
1P

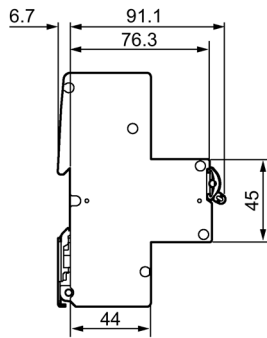

11.6 Dimensional drawings

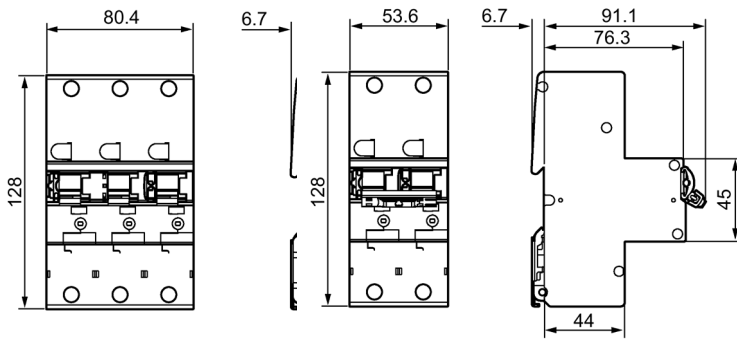

5SP38..-3
3x1P

5SP32..-3
2P

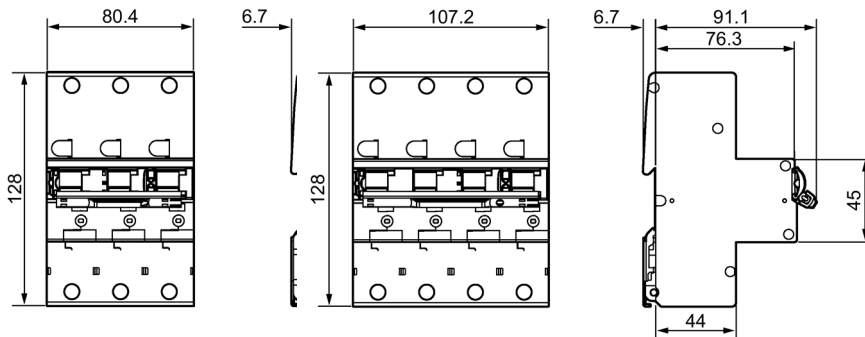

5SP33..-3
3SP

5SP34..-3
4P

11.7 Circuit diagrams



5SP38..-2 (3x1P)



5SP32..-3 (2P)



5SP33..-3 (3P)

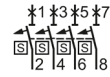

5SP34..-3 (4P)

5SY1 and 5SK9 circuit breakers for equipment

12.1 Overview

Ideal for devices in industry

Circuit breakers for equipment from Siemens offer optimum protection for all applications in AC and DC control circuits in industrial applications and plant engineering. 5SY17 thermomagnetic circuit breakers for equipment are used to protect solenoid valves, servo motors, signal lamps or even PLC inputs. Everywhere where loads have to be precisely protected from overloads and short-circuits. 5SK9 electronic circuit breakers for equipment are optimally suited to protecting, for example, relays, programmable controllers, motors, sensors, actuators and valves. A current analysis in conjunction with fast tripping in the event of a fault avoid the danger of overloading the switched-mode power supply.

12.2 Technical specifications

Circuit breakers for equipment	Type	5SY17	5SK9	
Standards		IEC / EN 60934, UL 1077	EN 61000-6-2, EN 61000-6-3, EN 60068-2-78, EN 50178, EN 60068-2-6, EN 60068-2-27, UL 508, UL 2367	
Approvals		see internet (www.siemens.com/lowvoltage/certificates)		
Rated current	A	0.5 ... 16	1 ... 8	
Number of poles		1P+AS		
DC tripping				
• Magnetic		F1 (2.5 ... 4 x I _n) F2 (4 ... 7 x I _n)	--	
• Thermal		1.05 x holding current 1.35 x tripping current TC3 1.35 x I _n	--	
• Electronic		--	Overload 1.2 x I _n / 1s Short-circuit 2 x I _n / < 10ms	
Rated voltage U _n			--	
• Acc. to IEC/EN 60934	V	230	--	
• Acc. to UL 1077	V	277	--	
Operational voltage				
• Acc. to EN 60934	Min.	V AC	12 at a minimum current of 100 mA	--
• Acc. to UL 1077, CSA C22.2 No. 235	Min.	V AC	12 at a minimum current of 100 mA	--
• Acc. to EN 60934	Max.	V AC	250	--
• Acc. to UL 1077, CSA C22.2 No. 235	Max.	V AC	277	--
	Min.	V DC per pole	12 at a minimum current of 100 mA	--
	Max.	V DC per pole	72	30
Switching capacity at operational voltage	kA	3	--	
Rated impulse voltage U _{imp}	kV	4	0.5	
Rated frequency	Hz	50 / 60	--	
Pollution degree for overvoltage category acc. to IEC		2/III	--	
Terminal tightening torque	Nm	2.0 ... 2.5 max	--	
	lb/in	17.1 ... 22.1	--	
Mounting position				
Service life/endurance	Actuations	6000	--	
Ambient temperature	°C	-25 ... +60, max. 85% rel. humidity, > 45 °C max 0.056kg/m ³ abs. humidity	-25 ... +60 max. 95 % air humidity	
Storage temperature	°C	-40 ... +70		

Circuit breakers for equipment	Type	5SY17	5SK9
Standards		IEC / EN 60934, UL 1077	EN 61000-6-2, EN 61000-6-3, EN 60068-2-78, EN 50178, EN 60068-2-6, EN 60068-2-27, UL 508, UL 2367
Shock Acc. to IEC 60068-2-27	m/s ²	--	
Resistance to vibrations Acc. to IEC 60068-2-6	m/s ²	--	

12.3 Conductor cross-sections

Conductor cross-sections		5SY17	5SK9
<i>1 conductor</i>			
• Solid/stranded	mm ²	0.75 ... 16	0.2 ... 4
• Finely stranded with non-insulated end sleeve	mm ²	0.75 ... 10	0.2 ... 2.5
• Finely stranded with insulated end sleeve	mm ²	0.75 ... 10	0.2 ... 2.5
• Finely stranded without end sleeve	mm ²	0.75 ... 16	--
<i>2-wire, same cross-section, same conductor type</i>			
• Solid/stranded	mm ²	0.75 ... 4	--
• Finely stranded with non-insulated end sleeve	mm ²	0.75 ... 2.5	--
• Finely stranded with insulated end sleeve	mm ²	0.75 ... 1.5	--
• Finely stranded without end sleeve	mm ²	0.75 ... 4	--

12.4 Configuration

5SY1 internal resistances and power losses

- Internal resistance R_i and power loss P_v at I_n warm

Type	Rated current I_n	F1		F2	
		R_i	P_v	R_i	P_v
	A	m Ω	W	m Ω	W
5SY17	0.5	8000	2.00	7800	1.95
	1	2300	2.30	1400	1.40
	2	610	2.44	370	1.48
	4	140	2.24	100	1.60
	6	51	1.84	31	1.12
	8	37	2.37	21	1.34
	10	29	2.90	20	2.00
	16	12	3.07	10	2.56
Auxiliary switch max. $I_n = 6A$		5	0.18	5	0.18

12.5 Characteristic curves

Correction factors regarding delayed tripping current at different ambient temperatures for 5SY1

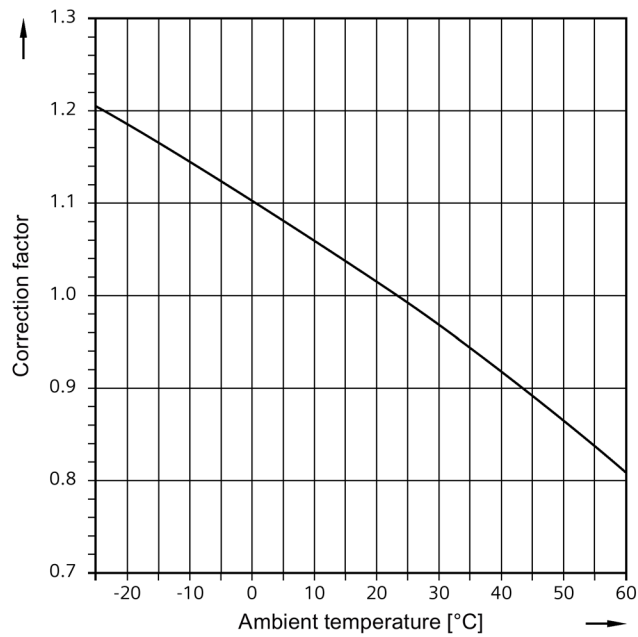

5SY1 impulse characteristic curve

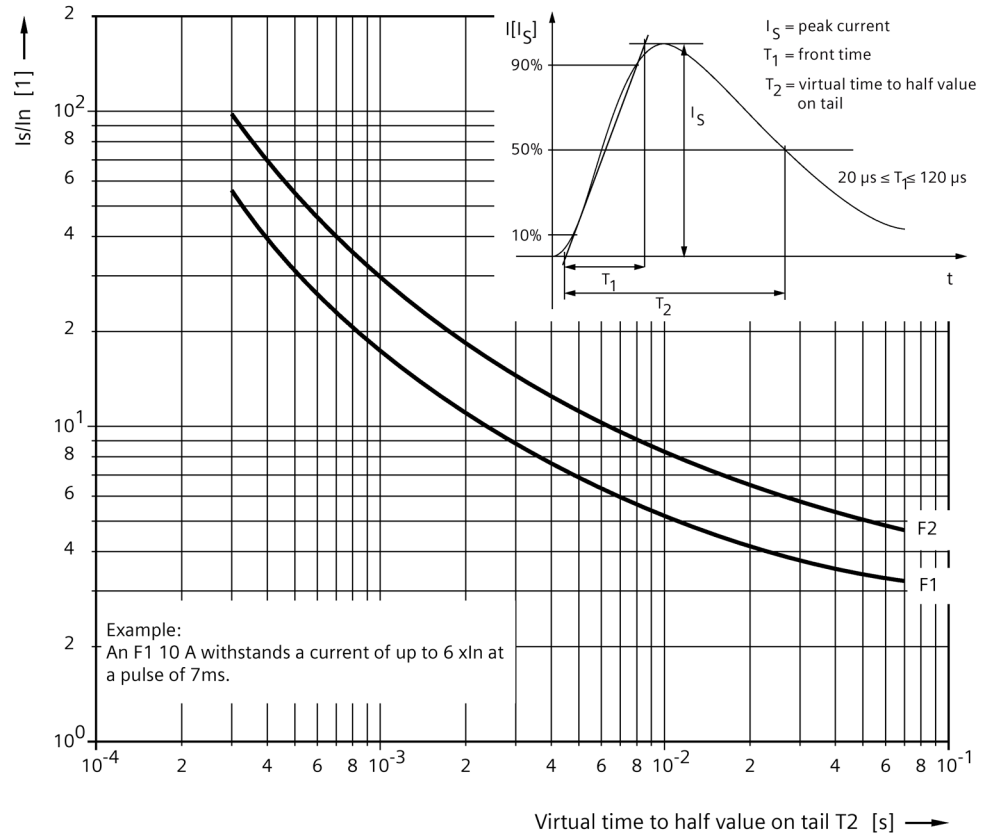

12.6 Dimensional drawings

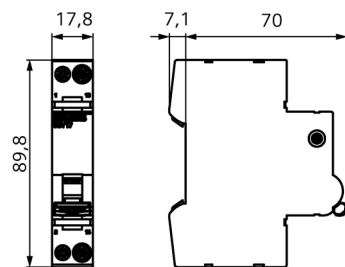

5SY1

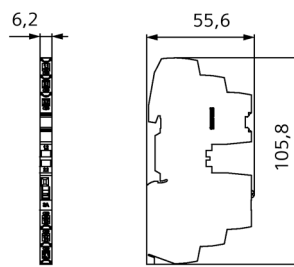

5SY1

12.7 Circuit diagrams



5SY1



5SK9

Further Information

Always at your disposal: our extensive support
www.siemens.com/online-support

Siemens AG
Smart Infrastructure
Electrical Products
Postfach 10 09 53
93009 REGENSBURG
Germany

Subject to change.

SI EP
online

