









PEFS Series Rapid Shutdown (3-5 strings)-P2



High Craftsmanship AND High Standards

- 
Small volume
- 
Flame retardant material
- 
Anti-UV
- 
Outdoor installation IP66
- 
Easy to install
- 
Service life 25 years
- 
High reliability
- 
OV output physical isolation
- 
Multiple shutdown methods over temperature/loss of pressure /emergency shutdown

Select Code

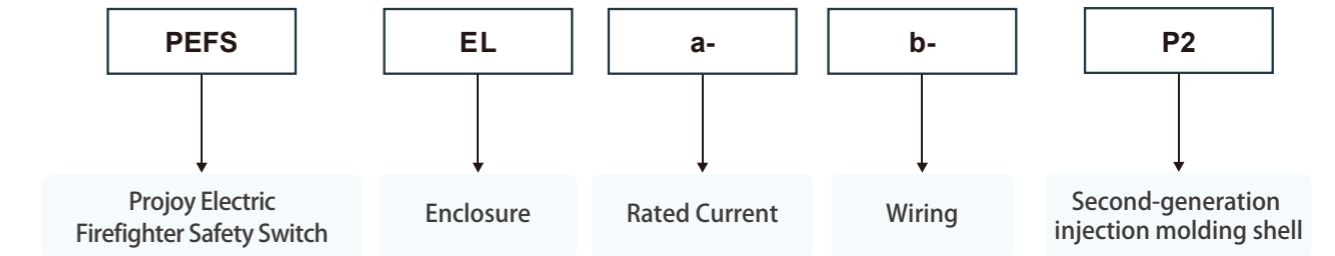

Models: PEFS-ELx-y. Rated current: x=16/25/32/40/55/40H/50H, Wiring types: y=6/8/10/6T/9T



When the current is greater than 40A, please select cable glands.

Diagram

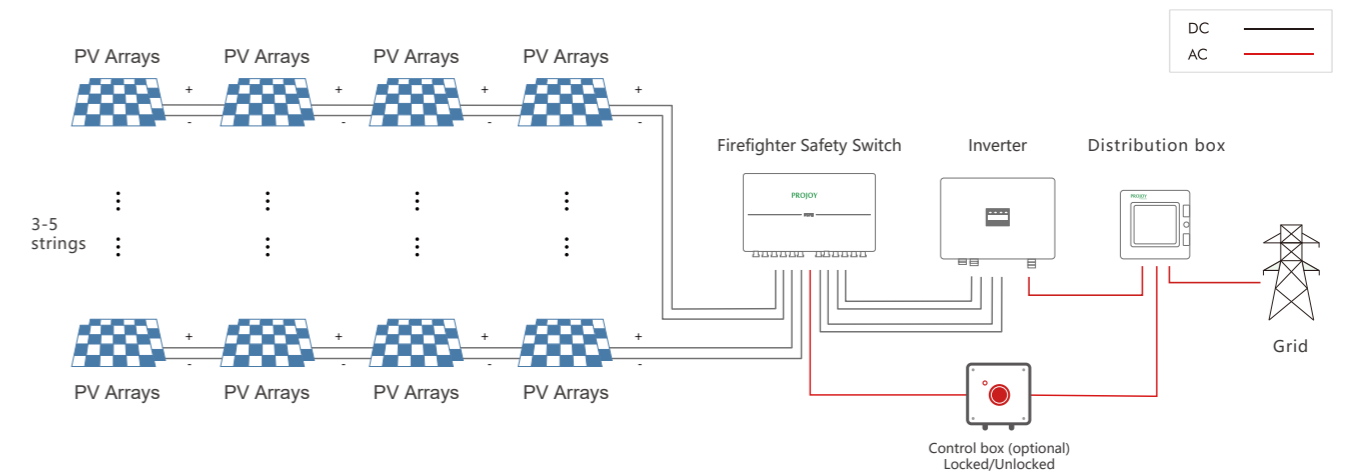

Shutdown Mode

Automatic Shutdown

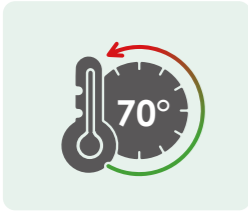

Automatically shutdown the DC power of panels when detecting temperature of the area is higher than 70°C.

AC Power Shutdown

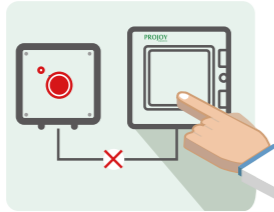

Firefighters or homeowners can manually turn off the AC power of the distribution box when in an emergency or it can automatic shutdown when the AC power has lose.

Manual Shutdown



In an emergency, it can be shut down manually through the Panel Level Rapid Shutdown Controller Box.

RS485 shutdown Optional



Maintenancers or homeowners can also remotely shutdown through RS485 communication (Optional).

Technical data

Technical Parameter	
Main Parameters	PEFS-P2
String voltages (Vdc)	300~1500
String current (A)	3~55
Number of strings	3~5
Switch wiring	6/8/10
Operating voltage	100Vac - 270Vac
Nominal voltage	230Vac
Nominal current	30mA
Start up (loading) current	average 100mA
Switch on action current	max 300mA
Feedback contact	24Vdc - 300mA max
Operating temperature range	-40°C - +70°C
Max. operating temperature before automatic switch off	+70°C
Storage temperature range	-40°C - +85°C
Protection degree	IP66
Protection level	Class II
Certification	CE
DC Switch disconnect according to	EN 60947-1&3
Number of operations	10000
Number of operations under load (PV1)	>1500

Data of PEFS refer to built-in DC isolators. Data according to IEC60947-3(ed.3.2):2015. Utilization category DC-PV1.						Poles	No. of Strings	Part Number
300V	600V	800V	1000V	1200V	1500V			
16	16	16	9	6	3	6/8/10	3/4/5	PEFS-EL16-6/8/10-P2
25	25	22	11	8	4	6/8/10	3/4/5	PEFS-EL25-6/8/10-P2
32	32	26	13	10	5	6/8/10	3/4/5	PEFS-EL32-6/8/10-P2
40	40	30	20	15	13	6/8/10	3/4/5	PEFS-EL40-6/8/10-P2
55	55	45	33	33	18	6/8/10	3/4/5	PEFS-EL55-6/8/10-P2
40	40	40	40	30	20	6/8/10	3/4/5	PEFS-EL40H-6/8/10-P2
50	50	50	50	40	30	6/8/10	3/4/5	PEFS-EL50H-6/8/10-P2

Contact Configuration

PEFS-P2 (3-5 String)

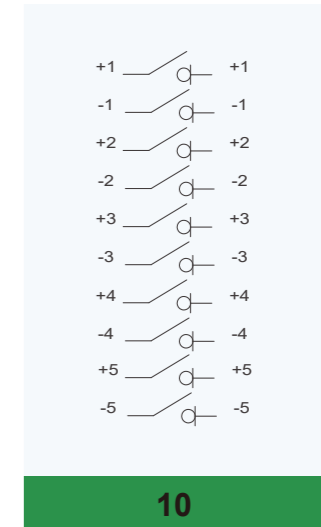
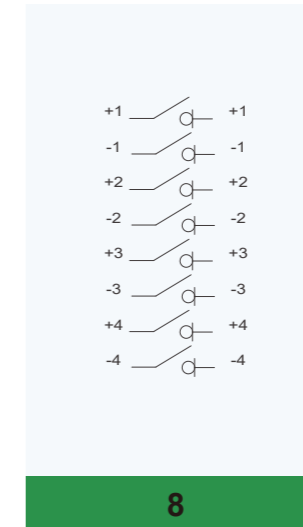
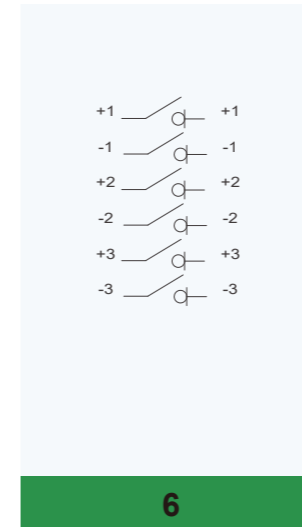

Dimensions of PEFS

PEFS-P2 (3-5 String)

